



We are passionate about delivering
quality, innovation and **service**



Marine

Leading Freshwater, Bilge and Waste Systems



Index

Company Overview 3-9

Electric Bilge Pumps

Automatic Range

Supersub Smart 12-13
Automatic narrow low profile range

NEW Orca Auto 1300 14-15
Compact, powerful and automatic

NEW Bilge IC 16-17
Prewired remote pump kit with intelligent control

Standard Range

For use with a separate bilge switch)

Supersub 18-19
Narrow low profile pump range

Orca 20-21
Compact and Powerful

Gulper 320 22-23
Remote mount bilge pump

Manual Bilge Pumps

Diecast Aluminium Alloy Range
(For long life)

Gusher 10 26-27

Gusher 30 28-29

Polypropylene Range

(Tough lightweight range)

Gusher Urchin 30-31

Gusher Titan 32-33

Mark V and Mark V
Double Acting 34-35

Compact Range

Compact 50 36-37

Smartbail 38

Portable Range

Easy Bailer 39

Bilge Accessories 40-43
Switches, pipework fittings, non return valves,
strum boxes/ strainers

Whale Support

Quick Guides - the easy way to find the Whale product you need Page 118-122
Where to Buy Page 124-125
Meet the Team Page 126-127
Support - Contact us Page 128

Freshwater

Electric Galley Pumps

NEW Fresh IC 46-47
Power shower pump with Intelligent control

Universal 48-49
Pressure pump range

Accumulator Kit 50-51
Expansion tank and pressure pump range

Submersible 52-53
Impeller pump range

Inline booster 54-55
Impeller pump range

Manual Galley Pumps

(Hand operated pumps)
V pump 56

Flipper 57

(Foot operated pumps)
Gusher Galley 58

Tiptoe/Babyfoot 59-60

Faucets

Elegance Faucet Range 62-63
ABS tough lightweight range

Metal Faucet Range 64-67
Chromed brass range

Showers

Elegance Internal Showers 68
ABS tough lightweight range

Internal Metal Showers 69
Chromed brass range

Deck/Transom Showers

NEW Twist Deck Shower Range 70-71
With unique integrated temperature
and flow controls

NEW Compact
Swim 'n' Rinse Range 72-73
Swim 'n' Rinse Range 74-75

Fresh Accessories 76-77
Filters, pressure switch
surge damper, pipework fittings

Washdown/Plumbing

Saltwater Washdown 80-82
Pump and trigger kits

Locker Doors 83

Quick Connect Plumbing 84-87
Pipework and fittings

Grey Waste

Electric Grey Waste Pumps

NEW Grey IC 90-91
Intelligent control kit for multiple drains

NEW Gulley IC 92-93
Intelligent control kit for single drains

NEW Gulper 320 94-95
High capacity waste pump
for fast drainage / multiple drains

Gulper 220 96-97
The original non clog Gulper grey waste pump

Grey Waste Tanks

Grey Waste Tank Range 98-99

NEW Grey Waste Tank and Pump Systems 100

Grey Waste Accessories 102

Pipework fittings, non-return valves,
strum boxes/ strainers

Fishbox/Livewell

Electric Pumps Range

Gulper Grouper 106-107

Gulper 320 108-109

Black Waste

Electric Pumps

Gulper Toilet Pump 112-113
Non choke electric black waste pump

Manual Pumps

Mk V Sanitation Pump 114-115
Manual waste pump

Black Accessories 116-117

Filters, pressure switch,
surge damper, pipework fittings



A contagious enthusiasm for innovation

*'Whale has led the way for many decades with **ground breaking** pump and water system designs through to recent **innovation leaps** in electronically controlled systems.*

*Our **forward thinking approach** is driven by dedicated people who exude a passion for delivering the best possible product and service for customers'.*



Patrick Hurst, Managing Director



Inside Whale

Whale® is a well - known brand with a reputation built on decades of high quality design expertise. Today, we supply marine customers around the world with innovative freshwater, bilge and waste pump and plumbing systems.

We are proud to design, manufacture and market Whale products and to export worldwide. We relish the opportunity to support our customers. We aim to provide best in class service from our base in Bangor, Northern Ireland, our Whale sales offices in UK, USA, France and Sweden, and through our worldwide distribution network.

Whale CE Approved

All Whale electrical products have the appropriate CE Mark, hence conforming to the relevant European Union Standard. It is not advisable to install electrical products which do not carry the CE Mark.

Whale Trade Names

Whale®, Gusher®, Gulper®, Babyfoot®, Whale Twist®, Deck Protect®, Smartbail® are registered trade names of Munster Simms Engineering Limited, Bangor, Northern Ireland.



WHALE SUPPORT

Our team is dedicated to providing excellent customer service and installation advice. Just call or email to speak to one of our technical advisors

Whale - Support

tel: +44 (0)28 9127 0531 fax: +44 (0)28 9146 6421
 info@whalepumps.com whalepumps.com

Whale - Support (The Americas)

tel: +1 802 367 1091 fax: +1 802 367 1095
 usasales@whalepumps.com whalepumps.com



Worldwide Distribution Network

Ensures that where Whale® products and spares are needed, they are available. See pages 124 for your nearest official Whale distributor.

Boat Builder Partnerships

'Our team includes highly skilled marine engineers who work in partnership with power and sailboat builders around the world. This collaboration delivers bespoke systems that are ideal for each builder, saving both time and money. To discuss options for partnering with Whale, please contact us today.'

Keith Nixon
 Business Development – Marine International
 keithn@whalepumps.com



Shelf Ready Range for Retailers

Whale's complete retail products includes a full range of spare parts. Our marketing team are happy to work with you to provide point of sale materials to help sell in store. For more information and latest product brochures, contact us today.'

Claire McCrea – Whale Marketing Manager
 clairemcc@whalepumps.com



Turn to page 126 to meet the Whale team



QUALITY Proud to manufacture in the UK. Our production team combine the latest technology with best in class lab testing

'Quality is central at everything we do at Whale. We continually evaluate our systems to drive improvement in design, build product and service quality. We endeavour to exceed customer expectations by implementing best practices, relevant ISO standards, and EFQM business excellence model to drive continuous improvement in all areas of our business.'

'In recognition of our strive of excellence the company was presented with the NI Quality Award in January 2011.'
Billy Burrows, Whale Quality Manager

Whale Production - Expertise and Technology

- **Expertise** - Latest manufacturing techniques applied by our skilled workforce.
- **Production** - Many staff with over 20 years of experience building Whale products.
- **Technology** - State of the art 'visual factory' system controls work flow.
- **Whale Tech Centre** - Our testing laboratory runs a programme of extended life testing, datalogging and trend analysis on all existing and new products. This ensures consistently robust products designed to withstand the harsh marine environment.

High Quality Manufacturing

- **Reassurance** -
100% of products are tested as part of the build process
All finished goods stock is batch tested
- **Integrity of components** -
Our in house injection moulding facility uses 100% virgin materials.



The Whale Drive for Quality

Skilled hands on Engineering and Quality teams

- Latest testing, datalogging and lean manufacturing.





From its origins in 1810, Whale has a heritage of product quality and customer orientation. Our team has led the way in water and waste management on board for more than 60 years

Whale Proud Heritage

A Reputation for Reliability

In 2010, Whale celebrated 200 years since our foundation. Since the 1940's we have been developing bilge, freshwater and wastewater products known for their quality and innovation. This tradition proudly continues today with our latest products.



System Solutions

- Bilge
- Fresh
- Washdown
- Quick Connect Plumbing
- Grey Waste
- Black Waste
- Fishbox / Baitwell

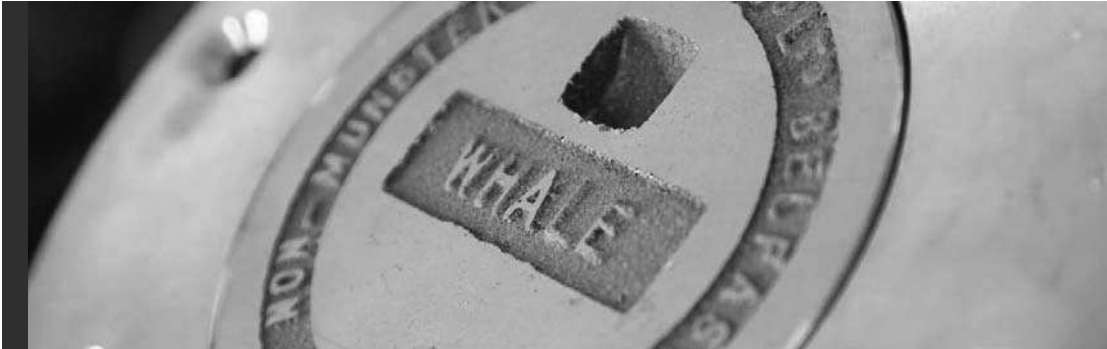

From the foundations of bilge pump design

During the 30s and 40s, Whale developed a range of high quality marine brass pumps fitted in naval and fishing fleets, and then into leisure marine applications in the 70s and 80s.

Offering support for the long haul

This brass range was manufactured through to the 1980s. Despite being out of production for more than 20 years, Whale continue to support the range with service and reconditioning for several models. For more information contact Whale Support.



Whale Support

UK

tel: +44 (0)28 9127 0531
 fax: +44 (0)28 9146 6421
 info@whalepumps.com
 whalepumps.com

USA

tel: +1 802 367 1091
 fax: +1 802 367 1095
 usasales@whalepumps.com
 whalepumps.com

Reputation for robust design and reliability

Today we use this solid foundation to continue to develop robust manual pumps, as well as leaping forward with the latest electronically controlled water and waste systems

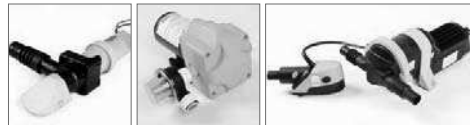

The Iconic Whale Gusher Bilge Pumps

Putting safety and reliability first for 60 years

Whale Intelligent Control

Intelligent pumps for intelligent boaters





Award winning designs, Whale's proven pioneering technology has led the way for decades

Whale IC Innovative Future

Latest technology

Innovative electronic circuitry lies at the heart of every Whale IC pump system

Simple, fast installation

Longer system life

Whale's best boater experience ever

Expertise in Electronics



See latest IC Products see pages:
12-17, 46-47 and 90-93



Award winning product design

There are heroes of innovation in all areas of our business from product manufacturing to design through to customer service. Our award winning product designs are the result.

Through the decades, Whale® has pioneered a stream of innovation from the early brass pumps to the market leading Gusher® manual bilge pumps and Gulper® electric waste pumps. In the last five years, Whale's new products such as Twist deck shower and Supersub Smart electric bilge pumps and Intelligent Control range have all been recognized by the marine industry innovation awards.

Over the last 3 years, 15 world-wide design patents have been registered, driven by a true culture of innovation within the business. Today Whale® remains at the leading edge of engineering technology with a 27 strong design team using state of the art CAD, data-logging and rapid prototyping equipment.

'I lead a team of really skilled and creative design engineers. Each person has their own area of expertise, but as a team we have a strong set of core engineering competencies such as mechanical pump and electronic design.'

Richard Bovill, Whale Design Engineering Manager



NEW FOR 2012

Orca Auto 1300 page 14
 Orca High Capacity Models page 20
 New Compact Swim 'n' Rinse page 72
 100 ltrs Grey Waste Tanks page 100
 NEW Electric Bilge Switches page 40





Whale - Electric Bilge Pump Range

From the Experts in Bilge Pumps
experience in electronics



Leaders in bilge pumps for more than 60 years

- Award winning new automatic pumps
- Narrow low profile pumps ideal solutions ideal for confined bilges
- Latest intelligent control technology

Automatic Electric Bilge Pump Range

No separate electric bilge switch needed



- Whale Supersub Smart - Narrow low profile automatic submersible pumps - Page 12-13
- NEW Orca Auto - Compact, powerful and automatic high capacity submersible pump - Page 14-15
- NEW Bilge IC - Remote mount complete automatic system - Page 16-17

Standard Submersible Bilge Pump Range

For use with separate electric bilge switch

- Supersub Standard - Narrow low profile submersible pumps - Page 18-19
- NEW Orca compact and powerful submersible pumps widest range Page 20-21
- NEW Orca high capacity models - Page 20-21
- Gulper® 320 - Remote mounted bilge pump - Page 22-23

Accessories

Complete the system with electric bilge switches, non-return valves, pipework fittings - Page 40-43

Supersub Smart Family



Low profile automatic bilge pumps sense bilge water level and switch on and off automatically

Fit deep down in confined bilge areas, under engines or cockpit floors



NEW Widest Range Ever

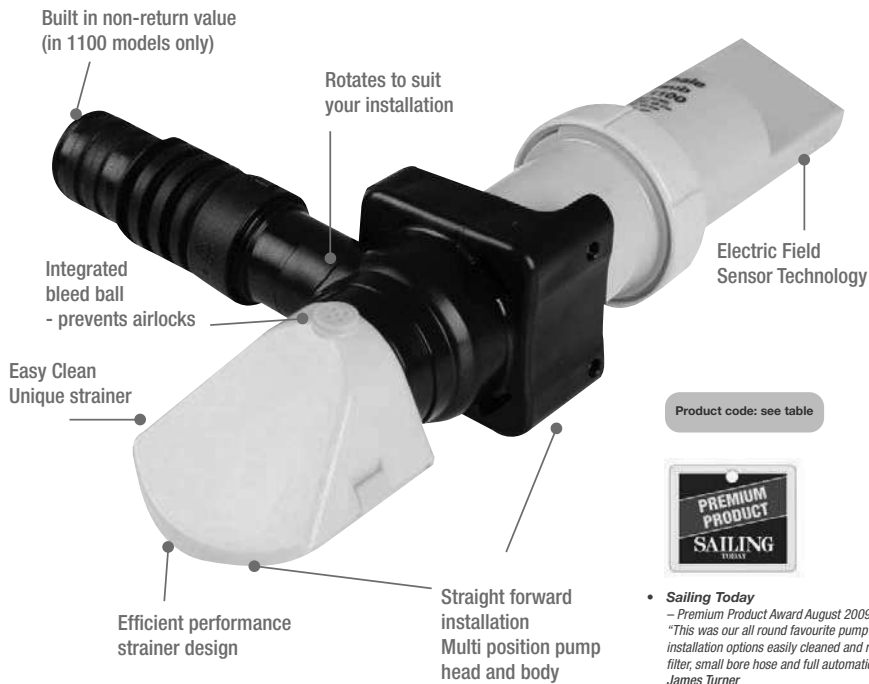

Product code: see table



- **Sailing Today**
– Premium Product Award August 2009
"This was our all round favourite pump with multiple installation options easily cleaned and removable filter, small bore hose and full automation."
James Turner
Sailing Today Group test - August 2009
- "This pump is easily the best working pump I have ever owned. I will recommend your company as I often service many boats."
Mr Ekberg, Boat Servicing Customer, Sweden
June 2011

Features and Benefits

WHY Supersub Smart?

- Fits deep in the bilge where other pumps can't
- No separate bilge switch required
- Automatically controlled patented electric field sensor detects water level
- Waterproof electronics- protected against water ingress
- Quick and easy installation - extra long wires, strainer and outlet rotate to suit your bilge area
- Unaffected by wave motion
- Environmentally friendly - mercury free
- Includes manual override facility
- Solid State switching - no moving parts

1 Year Warranty

Tips

- Easy clean
- unique clever strainer design
- easy to remove and replace for cleaning

Awards and Accreditations

- Quaitec award
- Menzione Speciale 2009
- NMMA Innovation Award
- Honourable Mention 2009



Approvals and Standards

- Conforms to ISO 8849 and ISO 15083
- Ignition protected per ABYC and USCG standards
- CE certified Directive 89/336/EEC - EMC compliant
- NMMA type approved

ELECTRIC BILGE



Product Information



Model Specifications

Model	Supersub Smart - Low Profile Automatic Bilge Pump		
	SS5212	SS1212	SS1224
Open Flow Rate @ 13.6 V d.c.	650 GPH (40 ltrs/min)	1050 GPH (66 ltrs/min)	1050 GPH (66 ltrs/min)
Flow Rate @ 1m Head	550 US GPH (34 ltrs/min)	750 GPH (47 ltrs/min)	750 GPH (47 ltrs/min)
Nominal Voltage	12 V d.c.	12 V d.c.	24 V d.c.
Current Draw	3.4 Amps	4.3 Amps	2.2 Amps
Recommended Fuse Size	5 Amp automotive	7 Amp automotive	5 Amp automotive
Wire Size (Cauked Wire)	1.5mm (16 AWG)	1.5mm (16 AWG)	1.5mm (16 AWG)
Weight	0.326 kg (0.71 lbs)	0.45 kg (0.99 lbs)	0.45 kg (0.99 lbs)
Maximum Discharge Head	3m (10ft)	3m (10ft)	3m (10ft)
Hose Connections	19mm (¾")	25 / 28mm (1" - 1 ¼") Stepped port	25 / 28mm (1" - 1 ¼") Stepped port
Materials	Pump Body; polypropylene, high temperature ABS, fully potted circuitry. Locking Ring; acetal, Impeller; glass-filled PBT Seals; Nitrile®, Fasteners; stainless steel.		
Overall height	75mm (3")	75mm (3")	75mm (3")
Overall Width	54mm (2 ¼")	54mm (2 ¼")	54mm (2 ¼")
Overall Length	212mm (8 ¾")	240mm (9 ½")	240mm (9 ½")

Note: For wiring advice on your installation, please contact Whale.
These specifications are retail items only.

For details of our bulk pack range for boat builders and wholesalers - contact Whale Support.

Flow rates quoted are based on Whale laboratory tests without a non-return valve included.

Typical Installations

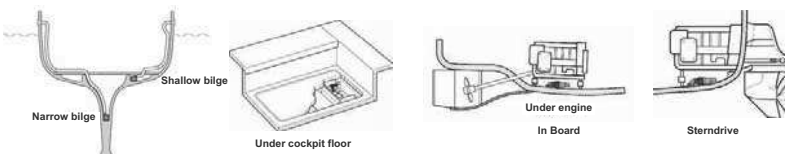

COMPLETE YOUR SYSTEM

Whale high quality bilge accessories including non-return valves (LV1219 for use with 650 model only) elbows and y pieces. Page 40-43

YOU MAY ALSO LIKE

NEW Orca Auto 1300 – page 14

NEW Bilge IC - Pre-wired Remote Mounted Bilge System with automatic intelligent control built in - page 16

NEW Grey IC and Gulley IC
– Automatic Grey Waste systems
– pages 90 and 92

DIMENSIONS FOR 650 MODEL

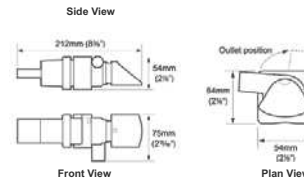

DIMENSIONS FOR 1100 MODEL



Orca Auto 1300



NEW Compact, powerful and automatic

Submersible bilge pump with large footprint to ensure maximum surface area exposure to bilge water

- no separate bilge switch required!

Integrated Electronics
Fully potted IC built in intelligent control.
Microprocessor electronics sealed for protection against water ingress

Fully Protected
Robust housing made from fuel resistant ABS

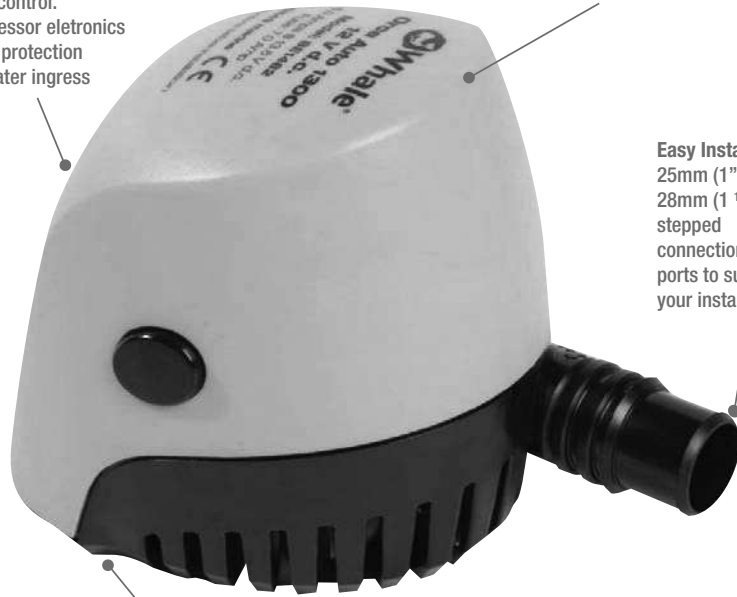

Easy Install
25mm (1")
28mm (1 1/8")
stepped
connection
ports to suit
your installation

Efficiency
Large surface area ensures maximum area exposed to bilge water

Product code: see table

Features and Benefits

• WHY ORCA AUTO 1300?

Introducing Whale's latest addition to our intelligent automatic electric bilge pump range

- High performance - 1300 US gals/hr flow rate
- Simple to install - built in automatic sensor
- No separate bilge switch is required
- Long battery life - low amp draw
- Neat fit in compact bilge areas
- ABS fuel - resistant housing
- Efficient - large filter ensures maximum surface area exposed to bilge water

1 Year Warranty

Awards and Accreditations

- Conforms to ISO 8849
- CE certified
- Directive 89/336/EEC – EMC compliant

COMPLETE YOUR SYSTEM

Bilge system accessories including non –return valves, elbows and y pieces. Page 40-43

YOU MAY ALSO LIKE

- Supersub Smart
– Narrow low profile automatic electric bilge pumps – page 12
- Bilge IC
– The remote Mounted pre assembled bilge pump kit with Intelligent control built in – page 16

i Product Information



Model Specifications

Product Code	NEW Whale Orca Auto 1300	
	BE1482	BE1484
Nominal Voltage	12 V d.c.	24 V d.c.
Open Flow Rate @13.6 V d.c.	1300 US GPH (82 l/min)	1300 US GPH (82 l/min)
Flow rate at 1m (3ft) head	1100 GPH (65 l/min)	1100 GPH (65 l/min)
Current Draw	5 Amps	2.5 Amps
Recommended Automotive Fuse Size	7 Amp	5 Amp
Weight	0.9 kg (2lbs)	
Hose Connection	Stepped ports 1" and 1 1/4"	
Wire Size	16 AWG x 1m (3ft)	
Maximum Discharge Head	4.5m (14.8ft)	
Overall Height	129mm (5.1")	
Overall Width	168mm (6.6")	
Overall depth	121mm (4.8")	
Materials	Pump Body- ABS, Seals: Nitrile®, Impeller: Acetal	

Note: For wiring advice on your installation, please contact Whale.
These specifications are retail items only. For details of our bulk pack range for boat builders and wholesalers - contact Whale Support

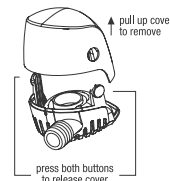

Easy maintenance

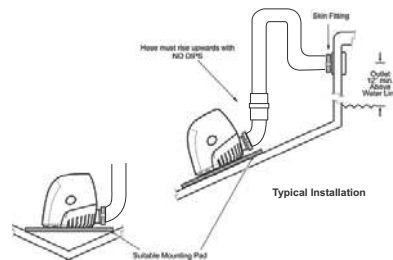

Typical Installation

Bilge IC



NEW Pre-wired Easy Access Remote Mounted Bilge System (4 in 1) with automatic intelligent control built in

Save time and money by reducing four separate components to one pre-wired system. Remote mounting automatic Gulper IC receives signals from Strainer IC and switches on and off automatically

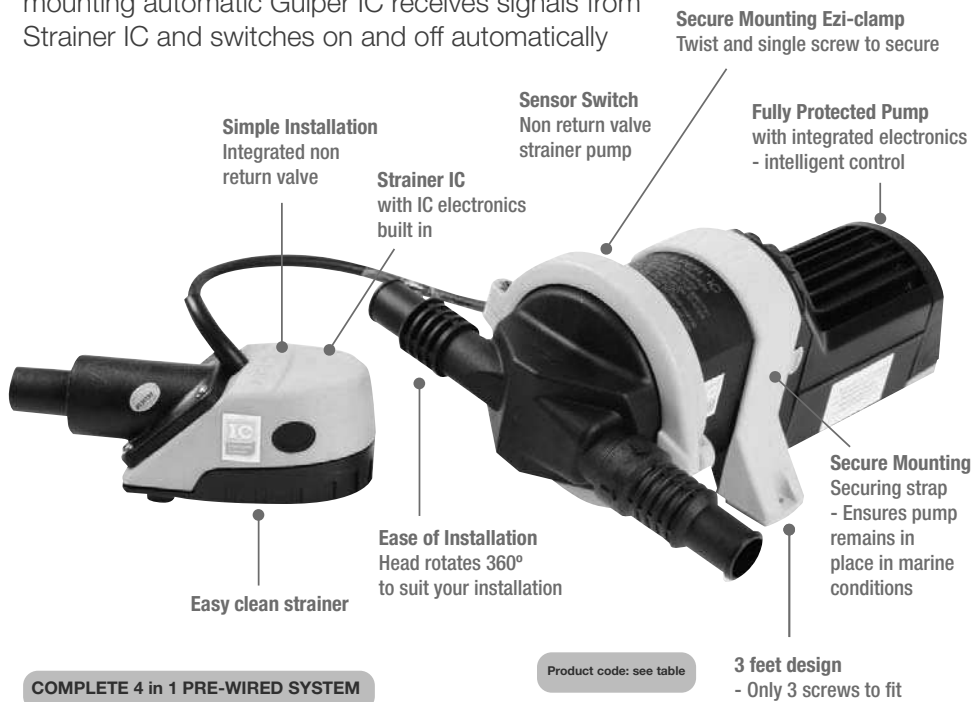

Complete your system intelligent pump, strainer, non return valve and intelligent digital switch in one

Features and Benefits

WHY Bilge IC?

- Pre-wired and assembled - just connect power
- Remote mounted pump for easy inspection
- Soft start - protects the pump for long life
- Small footprint strainer fits into very confined bilge spaces
- Low current controlled switching - no switch failure from high currents
- On/off delay - prevents cycling
- Environmentally friendly - no mercury
- Time delay to allow for optimum drainage
- Override wire included to allow for manual activation

1 Year Warranty

Tips

It is important to ensure that a vented anti-siphon loop is incorporated in the system



ELECTRIC BILGE

Awards and Accreditations

- Conforms to ISO 8849 and ISO 15083
- Ignition protected per ABYC and USCG standards
- CE certified
- Directive 89/336/EEC
- EMC compliant
- NMMA type accepted



COMPLETE YOUR SYSTEM

For bilge system accessories- see page 40-43



Product Information



Model Specifications

Model	Bilge IC	
	SI8284	SI8484
Product Code	SI8284	SI8484
Voltage	12 V d.c.	24 V d.c.
Voltage Range	10 V to 13.6 V d.c.	21.6 V to 27.2 V d.c.
Recommended Automotive Fuse Size	10 Amp	5 Amp
Minimum wire size	1.5 mm ² (16 AWG)	
Cable Length	4m (12ft)	
Current Profile	Soft start / stop	
Weight	2.6kg (6.5 lbs)	
Current draw on Standby	Low power 0.01 Amps supply	
Maximum Suction Lift	3m (10ft)	
Maximum Discharge Head	3m (10ft)	
Lift/head Combined	4m (12ft)	
Hose Connections	Gulper® IC - Barbed connections, 3/4" (19mm) or 1" (25mm) Strainer IC - 3/4" (19mm)	
Port Orientation	Horizontal (Easily changed to vertical)	
Connectors	IP68, Waterproof Quick Connect 7 way (directly onto Gulper® IC)	
Materials	Pump Head: Glass-filled Nylon, Valves - Nitrile®, Diaphragm: Santoprene®	
Materials in contact with fluid	Glass-filled Nylon, Nitrile®, Santoprene®	
Service Kits	AK2050 - Replacement Pump Head (available separately)	

Performance Data

Suction Lift	0m	0m	1m (3ft)	1m (3ft)
Discharge Head	1m (3ft)	1m (3ft)	1m (3ft)	1m (3ft)
Hose Size	3/4" (19mm)	1" (25mm)	3/4" (19mm)	1" (25mm)
Flow Rate/minute	300 US GPH (19 ltrs/min)	276 US GPH (17.5 ltrs/min)	270 US GPH (17.4 ltrs/min)	246 US GPH (15.5 ltrs/min)
Current Draw (12 V d.c.)	7.5 amps	8 amps	7.5 amps	8 amps
Current Draw (24 V d.c.)	3.25 amps	4 amps	3.25 amps	4 amps

Note: Maximum vertical lift not more than 3m (10ft)

Note: For wiring advice on your installation, please contact Whale.

NOTE: These specifications are retail items only. For details of our bulk pack range for boat builders and wholesalers - contact Whale Support

YOU MAY ALSO LIKE

Grey IC and Gulley IC - Automatic Grey waste pump kits with automatic intelligent control built in - see pages 90 and 92

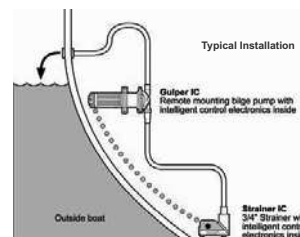
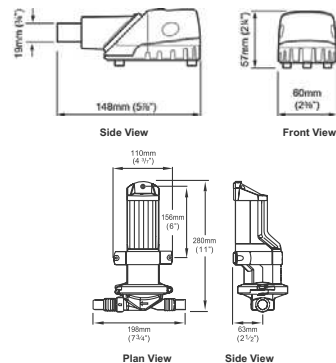

Supersub Family

Narrow low profile standard submersible bilge pumps now with higher capacity models. Designed for use with separate bilge switch.

Low profile electric bilge pump designed for narrow bilge spaces. Supersubs fit deep down in small / awkward bilge spaces where other pumps won't.



500



NEW 1100

NEW Widest Range Ever

Long term reliability
- comes with extra long wires for integrity

Simple plumbing
- 500 model - 19 mm (3/4")
1100 models - 25mm (1")
/ 28mm (1 1/8") stepped port
- ports can be rotated to suit your installation

This product is protected by the following granted patents:
United States Patent No. US 6,174,146; and United Kingdom Patent No. GB 2 328 719.

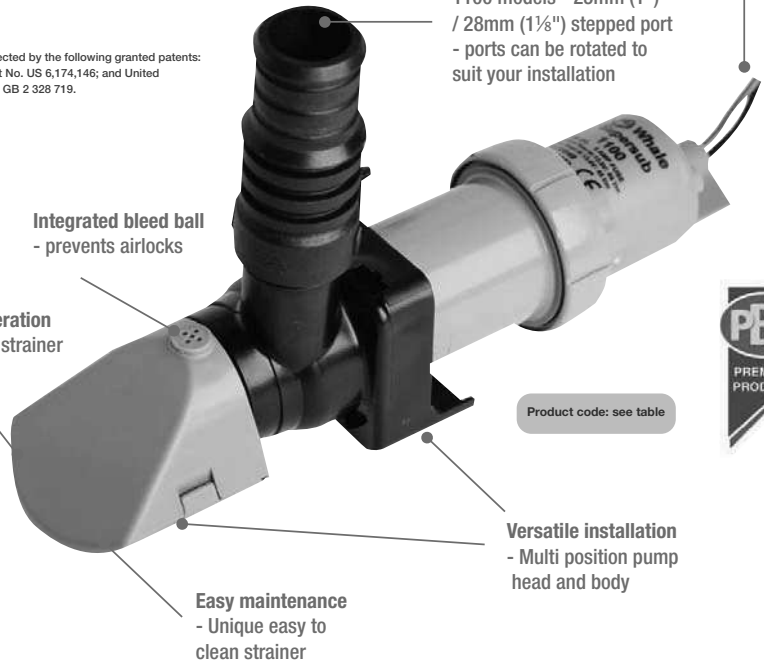

Integrated bleed ball
- prevents airlocks

Efficient operation
- low profile strainer

Easy maintenance
- Unique easy to clean strainer

Versatile installation
- Multi position pump head and body

Product code: see table



Features and Benefits

- Low narrow design for confined bilge spaces
- Easy installation - outlet and pump body rotate to suit your installation
- High performance
- Efficient operation
 - Very low power consumption
- Easy to clean - snap fit assembly
- Low profile strainer
 - Leaves the bilge almost dry

1 Year Warranty

Tips It is important to ensure that a vented anti-siphon loop is incorporated in the system



Awards and Accreditations

- PBO testers choice
- ## Approvals and Standards
- Conforms to ISO 8849 and ISO 15083

- Ignition protected per ABYC and USCG standards.
- CE certified Directive 89/336/EEC
- EMC compliant. NMMA type accepted

ELECTRIC BILGE

COMPLETE YOUR SYSTEM

See Page 40-43 for bilge system accessories

YOU MAY ALSO LIKE

Supersub Smart Family - The automatic range with built in intelligent control - no need for a separate bilge switch - page 12
 Orca Auto 1300 - Compact, powerful and automatic submersible bilge pump - page 14
 NEW Bilge IC - Pre-wired Remote Mounted Bilge System with automatic intelligent control built in - page 16

Product Information

Model Specifications			
Model	Supersub 500 (12 V d.c.) SS5012	Supersub 1100 (12 V d.c.) SS1012	Supersub 1100 (24 V d.c.) SS1024
Open Flow Rate @13.6 V d.c.	500 US GPH (32 ltrs/ min)	1050 US GPH (66 ltrs/ min)	
Flow Rate at 1M (3ft) head	400 US GPH (25 ltrs/ min)	750 US GPH (47 ltrs/ min)	
Nominal Voltage	12 V d.c.	12 V d.c.	24 V d.c.
Current Draw	2.4 Amp	4.3 Amp	2.2 Amp
Recommended Fuse Size (Automotive)	5 Amp	7 Amp	5 Amp
Weight	270g (0.6 lbs)	400g (0.9 lbs)	
Hose Connections	19 mm (3/4")	25mm / 28mm (1" / 1 1/8") stepped ports	
Minimum Wire Size	1.5 mm ² (16 AWG)		
Materials	Pump Body: Polypropylene, High Temperature ABS, Locking Ring: Acetal, Impeller: Glass-filled PBT, Seals: Nitrile®, Fasteners: Stainless Steel		
Materials In Contact With Fluid	Polypropylene, ABS, Glass-filled PBT, Nitrile®		
Accessories (available separately)	electric bilge switches BE9002 and BE9006 - for all bilge accessories see page 40-43 Non return valve LV1219		

Note: For wiring advice on your installation, please contact Whale.
 These specifications are retail items only.
 For details of our bulk pack range for boat builders and wholesalers - contact Whale Support.
 Please note: flow rates quoted are based on Whale laboratory tests without a non-return valve included.

DIMENSIONS FOR 500 MODEL

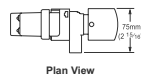
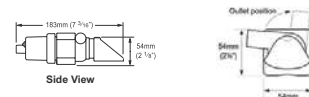

Front View

DIMENSIONS FOR 1100 MODEL Side View

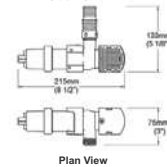
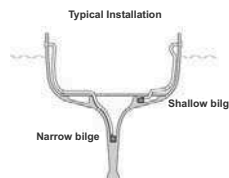

Plan View

Orca Electric Bilge Range

Orca- Compact and Powerful Electric Bilge Pump Range designed for use with a separate electric bilge switch Whales widest range of electric submersible bilge pumps ever
NEW HIGH CAPACITY MODELS

Efficient design with large footprint to ensure maximum surface area exposure to bilge water, now available in higher capacity 2000 and 3000 models.

Easy maintenance
- easy access to motor cartridge and filter

Easy release cover
- simply press both buttons and pull to release

Robust housing
- fuel resistant ABS

Efficiency
- large surface area ensures maximum area exposed to bilge water

Product code: see table



Versatile installation
- choose from multiple wire location options

Simple plumbing
500 models - 19 mm (3/4") ports
950, 1300 models - 25mm (1") or 28.5mm (1 1/8") stepped port connections
2000 models - 28.5mm (1 1/8")
3000 models - (32mm) (1 1/4")

NEW Widest Range Ever



Features and Benefits

- High performance
- Simple installation
 - Multiple wire locations
- Low amp draw means long battery life
- Easy maintenance
 - Access to motor cartridge and filter area
- Compact design
- Available in a range of 5 flow capacities
 - 500, 950, 1300, 2000 and 3000 US GPH
- 2000 and 3000 models self clearing
 - prevent cavitation

3 Year Warranty

Awards and Accreditations

- Meets ISO8849 marine standard
- CE certified

COMPLETE YOUR SYSTEM

Whale high quality bilge accessories including electric bilge switches, non-return valves, elbows and Y pieces. Page 40



BE9002 Floatswitch suitable for use with 12V d.c. or 24V d.c. pumps



NEW BE9003 Electric field sensor switch suitable for use with 12V d.c. or 24V d.c. pumps



NEW BE9006 Electric field sensor switch with built in time delay suitable for use with 12V d.c. or 24V d.c. pumps

i Product Information

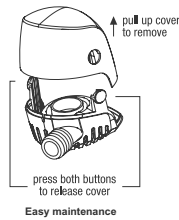
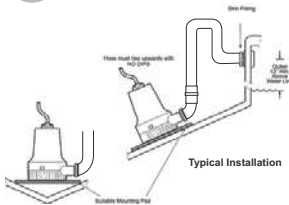

Easy maintenance

YOU MAY ALSO LIKE

Orca Auto 1300 – Compact, powerful and automatic submersible bilge pump – page 14

Supersub Smart Automatic narrow low profile submersible bilge pumps – page 12

Supersub – narrow low profile submersible bilge pumps (designed for use with a separate electric bilge switch – page 18)

Model Specifications

Model	500 US GPH	950 US GPH	1300 US GPH	1300 US GPH	2000 US GPH	3000 US GPH		
Product Code	BE0500	BE0950	BE1450	BE1454	BE2002	BE2004	BE3002	BE3004
Open Flow Rate @13.6 V d.c.	500 GPH (32 l/min)	950 GPH (59 l/min)	1300 GPH (82 l/min)		2000 US GPH (126 l/min)	3000 US GPH (189 l/min)		
Flow Rate at 1m (3ft) head	450 GPH (28 l/min)	850 GPH (53 l/min)	1100 GPH (69 l/min)		1650 US GPH (104 l/min)	2700 US GPH (170 l/min)		
Nominal Voltage	12 V d.c.		24 V d.c.		12 V d.c.	24 V d.c.	12 V d.c.	24 V d.c.
Current Draw	1.5 amps	3.5 amps	5.0 amps	2.5 amps	10 amps	5.0 amps	18 amps	9 amps
Recommended Automotive Fuse	2.0 Amp	5.0 Amp	7.0 Amp	5.0 Amp	15 Amp	8 Amp	27 Amp	13 Amp
Weight	0.28 kg. (0.6lbs)	0.45 kg. (1 lb)	0.82 kg. (1.8 lbs)					
Hose Connection	3/4" (19mm)	1 1/16" (25/28.5mm)	1 1/16" (25/28.5mm)		1 1/4" (28.5mm)	1 1/4" (32mm)		
Wire Size	1.5mm ² (16 AWG)							
Materials	Pump Body- ABS, Seals: Nitrile®, Impeller: Acetal							
Maximum Discharge Head	3 m (9.8ft)	3.5m (11.5ft)	4.5m (14.8ft)		4 m (13 ft)	4.6 m (15ft)		
Overall Height	83mm (3.3")	109mm (4.3")	129mm (5.1")		165mm (6.5")	195mm (7.7")		
Overall Width	102mm (4")	135mm (5.3")	168mm (6.6")		144mm (5.7")	166mm (6.5")		
Overall Depth	78.5mm (3.1")	103mm (4.1")	121mm (4.8")		120.5mm (4.74")	132mm (5.1")		

Note: These specifications are retail items only.

For details of our bulk pack range for boat builders and wholesalers - contact Whale Support.

Gulper® 320

Easy Access Remote Mount Bilge Pump High, Dry and protected - remote mounted for easy inspection

No clog, no filter waste pump built on more than a decade of market leading pump technology



Features and Benefits

- Easy Access Remote Mount Bilge Pump – Remote mounting allows easy access
- Meets requirement for primary bilge pump for boats up to 12m (39.4ft) length
- Ideal where bilge space is limited
- Long life high, dry and protected

3 Year Warranty

Awards and Accreditations

- ISO15083 Marine standard suitable as a primary bilge pump (for vessels up to 12m in length) or secondary bilge pump in accordance with ISO8849.
- Ignition protection ISO8846.
- CE marked.

COMPLETE YOUR SYSTEM

See page 40-43 for bilge accessories

YOU MAY ALSO LIKE

Bilge IC - Pre-wired Automatic Bilge System with Intelligent Control built in - page 16

Supersub Smart - Narrow low profile Automatic Electric Bilge Pumps with Intelligent Control built in - page 12

Product Information

Model Specifications

Model	Gulper® 320	
Product Code (retail)	BP2052 (includes 3/4" strainer)	BP2054 (includes 1" strainer)
Voltage	12 V d.c.	24 V d.c.
Hose Connections	3/4" (19mm) + 1" (25mm)	
Recommended Fuse Size	10 Amp Automotive	5 Amp Automotive
Minimum Wire Size	1.5 mm ² (16 AWG)	
Weight	1.6 kg (3.5 lbs)	
Materials	Pump Head: Glass-filled Nylon, Valves and Diaphragm: Santoprene®	
Accessories	SB3422 (19mm) strainer (multi-directional port) Service Kit: AK2050 - replacement pump head	
Maximum Suction Lift	3m (10ft)	
Maximum Discharge Head	3m (10ft)	
Maximum Discharge Head and Suction Lift Combined	4m (13.5ft)	

Performance Data

Model	BP2052 / BP2054			
Suction Lift	0m	0m	1m (3ft)	1m (3ft)
Discharge Head	1m (3ft)	1m (3ft)	1m (3ft)	1m (3ft)
Hose Size	3/4" (19mm)	1" (25mm)	3/4" (19mm)	1" (25mm)
Flow Rate per Minute	19 ltrs (5 US Gals)	17.5 ltrs (4.6 US Gals)	17.4 ltrs (4.5 US Gals)	15.5 ltrs (4.1 US Gals)
Current Draw	7.5 amps (12 V.d.c.) 3.25 amps (24 V.d.c.)	8 amps (12 V.d.c.) 4 amps (24 V.d.c.)	7.5 amps (12 V.d.c.) 3.25 amps (24 V.d.c.)	8 amps (12 V.d.c.) 4 amps (24 V.d.c.)

Note: These specifications are retail items only.
For details of our bulk pack range for boat builders and wholesalers - contact Whale Support.

EASY ACCESS FOR INSPECTION

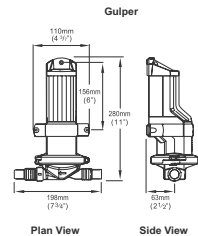
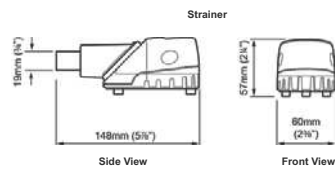
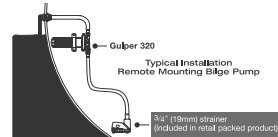



Whale - Manual Bilge Pump Range

Putting safety and reliability first for more than 60 years

The experts in manual bilge pumps

Up to 5 year warranty



Since the 1940s Whale engineers have refined our manual bilge pump designs and completed extended life testing - the result? Whale's iconic manual bilge pump range. Pumps manufactured by hand using high grade materials based on more than 60 years experience

Gusher® Range

Long Life Diecast Alloy Models

- Gusher 10 - Page 26-27
- Gusher 30 - Page 28-29

Gusher® Range

Tough and Lightweight Polypropylene Models

- Gusher Urchin - Page 30-31
- Gusher Titan - Page 32-33
- Mark V and Double Acting - Page 34-35

Low Profile

Compact Range

- Compac 50 - Page 36-37
- Smartbail - Page 38

Portable

- Easybailer - Page 39

Accessories

Complete the system with electric bilge switches, non-return valves, pipework fittings - Page 40-43

Note - Performance data quoted in this section is based on typical usage and Whale lab tests.
For information on our ISO certifications please contact Whale.

Whale's long life diecast alloy range

Gusher® 10

The original bilge pump choice for sailors in extreme conditions

Durable Diecast Alloy Bilge Pump
Top performance - 65 ltrs (17 US gals) / minute, robust design stands up to the toughest marine conditions



Features and Benefits

- Robust design stands up to the toughest marine conditions
- Top performance
 - 65 ltrs (17 US gals) per minute
- Mounting options On Deck / Bulkhead, Thru deck
- Designed for simple installation and maintenance
- Efficiency - Large non-choke valves
- Ideal for workboats, cruisers, offshore racing
- Easy pump action - Self priming
- Typical uses
 - Bilge pump out/ holding tank pump out

5 Year Warranty

Awards and Accreditations

Suitable as a primary bilge pump on boats equal to or greater than 12m (40ft) in accordance with ISO15083

COMPLETE YOUR SYSTEM

Whale high quality bilge accessories including non-return valves, elbows and Y pieces see page 40-43



Gusher 10 Mk3
Standard
BP3708

Gusher 10 Mk3
Thru Deck/Bulkhead
BP3740

Product Information

Model Specifications		
Model	On Deck / Bulkhead	Thru Deck / Bulkhead (includes deck plate)
Product Code	BP3708	BP3740
Weight	2.3 kg (5 lbs)	
Hose Connections	38 mm (1½") Smooth Hose Connections	
Materials	Pump Body: Marine Grade LM6 Aluminium Alloy (epoxy coated) Diaphragm: Neoprene (Nitrile® option available) Fasteners: Stainless Steel	
Materials Contact With Fluid	Marine Grade LM6 Aluminium Alloy (Epoxy Coated) Neoprene, Nitrile®, Stainless Steel	
Service Kits	AK3706 - Neoprene Parts AK3714 - Nitrile® Parts for Oil and Diesel Contains: Diaphragm, Valves, Seals	
Accessories	DP3904 - Alloy Deck Plate DP8904 - Plastic Deck Plate Lid AS4405 - Spare Handle	
Maximum Suction Lift	4 m (13.5 ft)	
Maximum Discharge Head	4 m (13.5 ft)	
Performance Data		
	BP3708 / BP3740	BP3708 / BP3740
Suction Lift	1 m (3 ft)	2 m (6 ft)
Discharge Head	0.5 m (1.5 ft)	0.5 m (1.5 ft)
45 Strokes per Minute	41 ltrs (11 US gals)	41 ltrs (11 US gals)
70 Strokes per Minute	65 ltrs (17 US gals)	65 ltrs (17 US gals)

Note: These specifications are retail items only.
For details of our bulk pack range for boat builders and wholesalers - contact Whale Support.

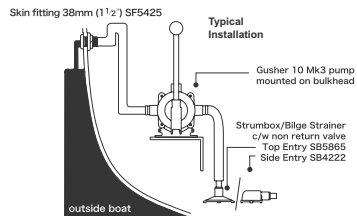
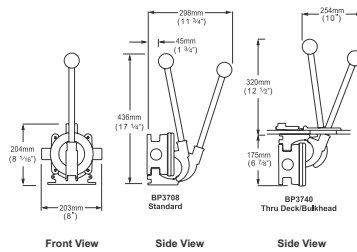

Whale's long life diecast alloy range

Gusher® 30

GUSHER 30 is our largest capacity manual bilge pump. Manufactured by hand using high grade materials based on more than 60 years experience. The heavy duty Gusher 30 is ideal when long term durability and high performance is vital.



Long term reliability
fully protected diaphragms

Ease of use
easy grip handle

Ease of operation
extra long handle

Robust design
corrosion resistant, powder-coated,
die-cast aluminium alloy

Simple plumbing
38mm (1½")
hose connections

Efficiency
high capacity double acting pump

Product code: see table

Features and Benefits

- Maximum output
 - Delivering over 117 ltrs (31 US gals) per minute
- Efficient operation
 - Double acting pumps on both to and fro strokes
- Reliability
 - Twin diaphragms ensure pump continues working if one is damaged
- Durability
 - Powder coated diecast aluminium alloy
- Pumps oily bilge water
- No tools required for inspection and cleaning
- 3 mounting options
 - Available for deck, bulkhead or underdeck mount (deckplate included with BP3020)

5 Year Warranty

Tips It is important to ensure that a vented anti-siphon loop is incorporated in the system

Awards and Accreditations

- Pump accepted on some vessels for use as an emergency fire pump
- Suitable as a primary bilge pump on boats equal to or greater than 12 m (40ft) in accordance with ISO15083



Life Boats Approval

- Approved by Lloyds (MCA) and USCG

COMPLETE YOUR SYSTEM

Whale high quality bilge accessories including non-return valves, elbows and Y pieces see page 40-43

i Product Information

Model Specifications

Model Product Code	On Deck BP3000	On Bulkhead BP3010	Thru Deck Only BP3020
Hose Connections	38 mm (1 1/2") Hose Connections		
Weight	5.05 kg (11.1 lbs)		5.9 kg (13 lbs)
Materials	Pump Body: Marine Grade LM6 Aluminium Alloy (epoxy coated) Diaphragm: Neoprene, Bushes: Acetal, Handwheels: Nylon Fasteners: Stainless Steel		
Materials In Contact With Fluid	Marine Grade LM6 Aluminium Alloy (epoxy coated) Neoprene, Stainless Steel		
Service Kit	AK3051 - Service Kit for Gusher® 30 Contains: Diaphragms, Valves, Gasket AK3020 - Thru Deck Conversion Kit (for BP3000, includes DP3804 and bridge section)		
Accessories	AS3095 - Spare Handle DP3804 Deckplate, AS3020 Deckplate Conversion Kit		
Maximum Suction Lift	4 m (13.5 ft)		
Maximum Discharge Head	4 m (13.5 ft)		

Performance Data

	BP3000 / BP3010 BP3020	BP3000 / BP3010 BP3020	BP3000 / BP3010 BP3020
Suction Lift	0	1 m (3 ft)	2 m (6 ft)
Discharge Head	0.5 m (1.5 ft)	0.5 m (1.5 ft)	0.5 m (1.5 ft)
45 Strokes per Minute	75 ltrs (20 US gals)	71 ltrs (19 US gals)	71 ltrs (19 US gals)
70 Strokes per Minute	117 ltrs (31 US gals)	111 ltrs (29 US gals)	111 ltrs (29 US gals)

Note: These specifications are retail items only.
For details of our bulk pack range for boat builders and wholesalers - contact Whale Support.

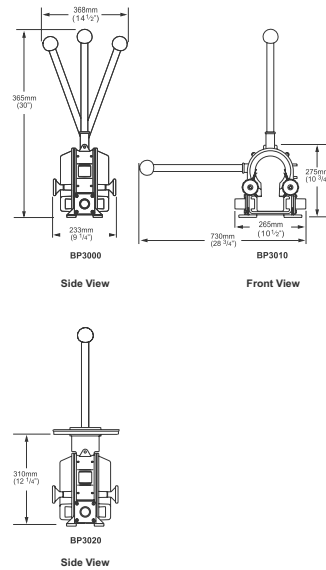

Whale's Tough and Lightweight Polypropylene Range

Gusher® Urchin

GUSHER URCHIN the ideal pump for confined bilge spaces

Manufactured by hand using high grade materials based on more than 60 years experience



Features and Benefits

Gusher Urchin - The compact and reliable pump ideal where space is limited.

- Ease of operation - Smooth action
- Clamp ring easily removed for pump head rotation and quick maintenance
- Versatility of design
 - Dual size nozzles for 25 mm (1") or 38 mm (1½") hose to suit your plumbing
- Efficient performance
 - up to 55 ltrs (14.5 US gals) per minute
- Three different mounting options (deck, bulkhead and thru deck models)

5 Year Warranty

Tips It is important to ensure that a vented anti-siphon loop is incorporated in the system

Awards and Accreditations

- 25mm (1") Hose connection - Suitable as a primary bilge pump on boats up to 12m (40ft) in accordance with ISO15083
- 38mm (1½") Hose connection - Suitable as a primary bilge pump on boats equal to or greater than 12m (40ft) up to 24m (80ft) in accordance with ISO15083

Product Information

Model Specifications

Model	On Deck Fixed Handle	Thru Deck / Bulkhead (includes deckplate)	On Deck Removable Handle
Product Code	BP9005	BP9013	BP9021
Weight	0.6 kg (1.3 lbs)	0.96 kg (2 lbs)	0.7 kg (1.5 lbs)
Hose Connections	25 mm (1") or 38 mm or (1½") Smooth Hose Connections		
Materials	Pump Body: Glass-filled Polypropylene, Clamp Ring: Acetal Diaphragm: Neoprene, (Nitrile® option available) Operating Lever (BP9021 and BP9013 only): Glass-filled Nylon Handle, Spring, Fasteners: Stainless Steel		
Materials In Contact With Fluid	Glass-filled Polypropylene, Nitrile®, Neoprene, Stainless Steel		
Service Kits	AK9003 - Neoprene Parts AK9011 - Nitrile® Parts for Oil and Diesel Contains: Diaphragms, Valves and Circlips		
Accessories	AS8680 - Spare Handle (for BP9013 & BP9021 only)		
Maximum Suction Lift	4 m (13.5 ft)		
Maximum Discharge Head	3 m (10 ft)		

Performance Data

	BP9005 / BP9013 / BP9021	BP9005 / BP9013 / BP9021
25 mm (1") Hose		
Suction Lift	1 m (3 ft)	2 m (6 ft)
Discharge Head	0.5 m (1.5 ft)	0.5 m (1.5 ft)
45 Strokes per Minute	25 ltrs (7 US gals)	25 ltrs (7 US gals)
70 Strokes per Minute	43 ltrs (11.4 US gals)	40 ltrs (10.6 US gals)
38 mm (1½") Hose		
Suction Lift	1 m (3 ft)	2 m (6 ft)
Discharge Head	0.5 m (1.5 ft)	0.5 m (1.5 ft)
45 Strokes per Minute	37.5 ltrs (9.9 US gals)	36 ltrs (9.5 US gals)
70 Strokes per Minute	55 ltrs (14.5 US gals)	53 ltrs (14 US gals)

Note: These specifications are retail items only.
For details of our bulk pack range for boat builders and wholesalers - contact Whale Support.

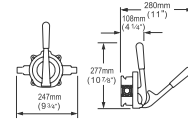

On Deck/Fixed Handle
BP9005
Plan View Side View

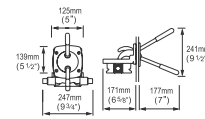

Thru Deck/Bulkhead
BP9013
Plan View Side View

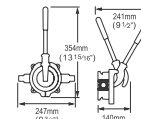

Bulkhead/Removable Handle
BP9021
Plan View Side View

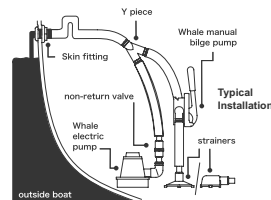

Whale's Tough and Lightweight Polypropylene Range

Gusher Titan

Tough and Lightweight Polypropylene Models

GUSHER TITAN combines powerful performance and lightweight design

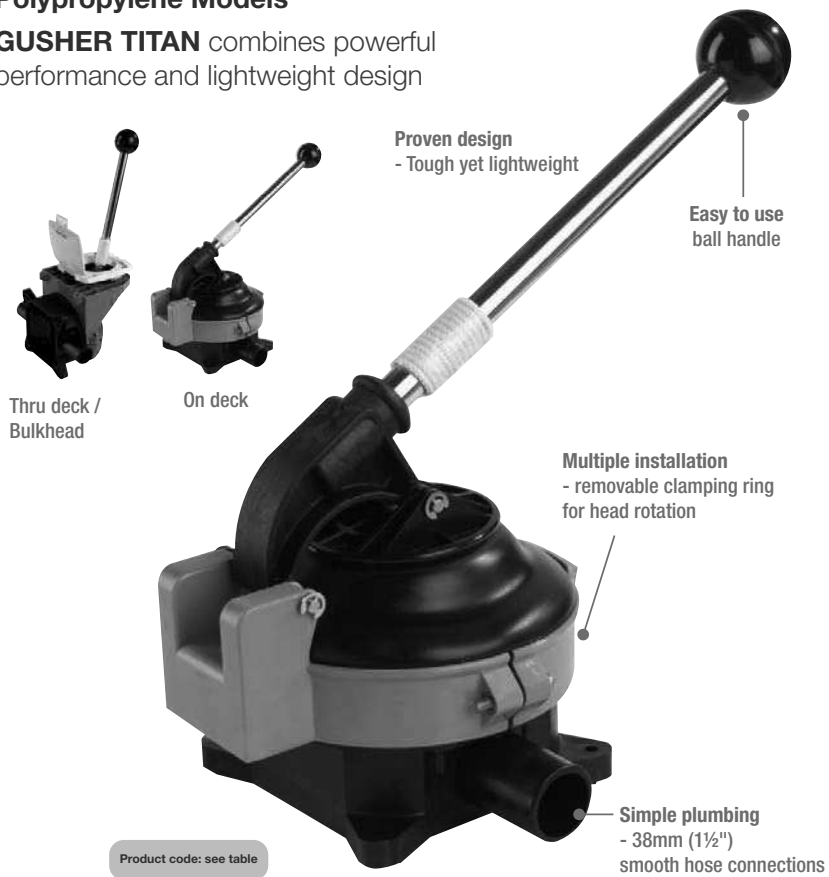

Features and Benefits

Whale's tough lightweight proven pump. A design that has been tried tested and trusted by sailors for decades.

- High flow rate: 105 ltrs (28 US gals) per minute
- Quick maintenance
 - Clamp ring easily removed for pump head rotation
- Tough, lightweight proven design
- 2 mounting options -bulkhead and thru deck models (with deckplate included)
- Suitable for use on boats over 12 m (40 ft)

5 Year Warranty

Tips It is important to ensure that a vented anti-siphon loop is incorporated in the system

Awards and Accreditations

- Suitable as a primary bilge pump on boats equal to or greater than 12 m (40ft) accordance with ISO15083

COMPLETE YOUR SYSTEM

Whale high quality bilge accessories including non-return valves, elbows and Y pieces see page 40-43

i Product Information

Model Specifications

Model	On Deck	Thru Deck / Bulkhead
Product Code	BP4402	BP4410
Weight	1.5 kg (3.3 lbs)	1.85 kg (4.1 lbs)
Hose Connections	38 mm (1 1/2") Smooth Hose Connections	
Materials	Pump Body: Glass-filled Polypropylene, Clamp Ring: Acetal Diaphragm and Valves: Neoprene, (Nitrile® option available) Operating Lever: Glass-filled Nylon, Gaiter: EPDM Fasteners: Stainless Steel	
Materials In Contact With Fluid	Glass-filled Polypropylene, Acetal, Neoprene, Nitrile®	
Service Kits	AK4400 - Neoprene Parts AK4419 - Nitrile® Parts for Oil and Diesel Contains: Diaphragm, Valves, Seals	
Accessories	DP6904 - Deck Plate Kit for BP4410 only AS4405 - Spare Handle	
Maximum Suction Lift	4 m (13.5 ft)	
Maximum Discharge Head	4 m (13.5 ft)	

Spares Kits

AK4400	Service Kit - Whale Gusher Titan Neoprene (for on deck installations) - diaphragm, valves and fixings
AK4419	Service Kit - Whale Gusher Titan Nitrile (for below deck installations) - diaphragm, valves and fixings
AS4406	Service kit - Whale Gusher Titan - Standard Lever Kit
AS4407	Service Kit - Whale Gusher Titan - Standard Clamping Ring Kit
AS4408	Service Kit - Whale Gusher Titan - Operating Lever U/Deck
AS4409	Service kit - Whale Gusher Titan - UnderDeck Clamping Ring Kit
AS4412	Service kit - Whale Gusher Titan - Clamping Plate Kit
AS3725	Service kit - Gaiter Kit For Deckplates (for underdeck models - Gusher 30 and 10, Titan, Urchin, MarkV)

Performance Data

	BP4402 / BP4410	BP4402 / BP4410
Suction Lift	1 m (3 ft)	2 m (6 ft)
Discharge Head	0.5 m (1.5 ft)	0.5 m (1.5 ft)
45 Strokes per Minute	67 ltrs (18 US gals)	65 ltrs (17 US gals)
70 Strokes per Minute	105 ltrs (28 US gals)	98 ltrs (26 US gals)

Note: These specifications are retail items only.
For details of our bulk pack range for boat builders and wholesalers - contact Whale Support.

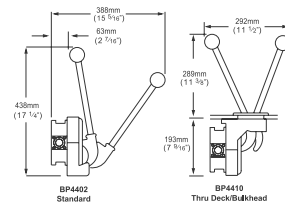

Side View

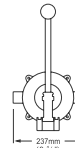

Plan View

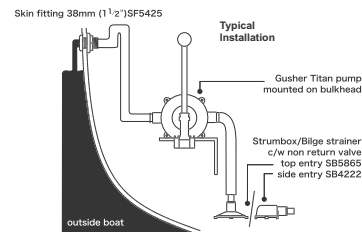

Typical Installation

Whale's Tough and Lightweight Polypropylene Range

Mk5 Range

Tough proven, reliable designs available with single or double acting capabilities

MK5 UNIVERSAL Manual Bilge Pump. Whale's most versatile high performance pump design. 3 mounting orientations – 1 pump

Product code: see table

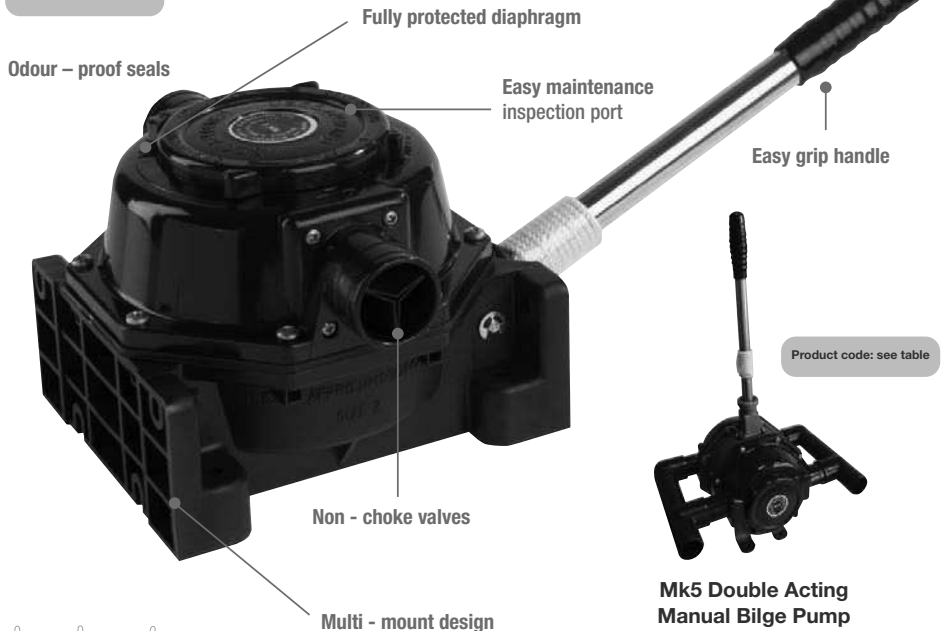

Product code: see table



Mk5 Double Acting Manual Bilge Pump

High output - 104 ltrs/23 US gals/minute
Twin diaphragms - empty 2 bilges compartments at the same time or one twice as quickly - 2 manifolds supplied

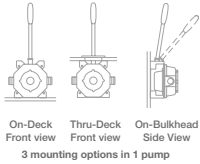

Features and Benefits

Mk5 Universal High Capacity Manual Bilge Pumps

- Three mounting options. A design that has been tried tested and trusted by sailors for decades. This clever bilge pump design allows great versatility in installation so that you can fit the pump in the orientation to best suit your boat.
- Whale's most versatile high performance pump design
- 3 mounting orientations
1 pump (on-deck, thru-deck, on-bulkhead)
- High Performance – flow rate (66 ltrs / 17.5 US gals / min)

Mk5 Double Acting high performance

- Ease of maintenance inspection hatch - no tools required
- Will continue to pump even if one diaphragm fails

5 Year Warranty

Tips

It is important to ensure that a vented anti-syphon loop is incorporated in the system

Awards and Accreditations

- Suitable as a primary bilge pump on boats equal to or greater than 12m (40ft) in accordance with ISO15083

Life Boats Approval

- Approved by Lloyds (MCA) and USCG (Mk5 Universal MCA - Size 2) (Mk5 Double Acting - Size 3)

Product Information

COMPLETE YOUR SYSTEM

Whale high quality bilge accessories including non-return valves, elbows and Y pieces see page 40-43

Model Specifications	Mk5 Universal Pump (Multiple Mounting Options)	Mk 5 - Double Acting Pumps		
Model	BP0510	MH5550 On bulkhead	MH5560 Thru deck	MH5570 On deck
Product Code	BP0510			
Weight	1.36 kg (3.0 lbs)	2.8 kg (6 lbs)		
Hose Connections	38 mm (1 1/2") Hose Connections			
Materials	Pump Body: Glass-filled Polypropylene, Diaphragm Valves and Seals: Nitrile®, Operating Lever: Acetal, Glass-filled Nylon Spring and Fasteners: Stainless Steel			
Materials In Contact With Fluid	Glass-filled Polypropylene, Acetal, Nitrile®, Stainless Steel			
Service Kit	AK8050 - Service Kit for Mk5 Contains: Diaphragms, Valves and Circlips AS0511 - Spare Handle AS0521 - rocker arm assembly AS0522 - Front cover / body assembly AS0531 - Under deck rocker arm assembly	AK8060 - Service Kit for Mk 5 D Acting - contains: Diaphragms, Valves and Circlips AS8551 - Rocker arm assembly AS8552 - Clamping plate and nut kit		
Accessories	AS3725 Gaiter Kit, DP9906 - Deck Plate Kit (includes cover)			
Maximum Suction Lift	4.5 m (15 ft)			
Maximum Discharge Head	4.5 m (15 ft)			

See page 121 for a full list of spares

Performance Data

	Mk5 Universal Pump	Mk 5 - Double Acting Pumps
Suction Lift		1 m (3 ft)
Discharge Head		0.5 m (1.5 ft)
45 Strokes per Minute	42 ltrs (11 US gals)	64 ltrs (17 US gals)
70 Strokes per Minute	66 ltrs (17.5 US gals)	104 ltr (27.5 US gals)

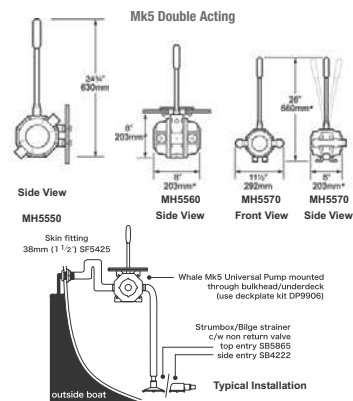
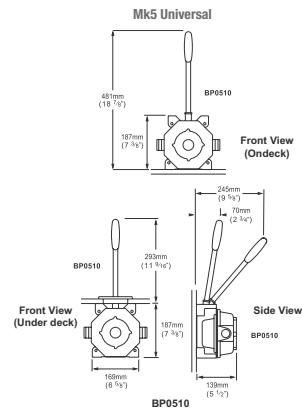

Whale's Compact Range

Compac 50

Designed for confined spaces where you have limited space to fit your pump

COMPAC 50 compact design easily installed in tight bilge spaces where other pumps simply cannot fit

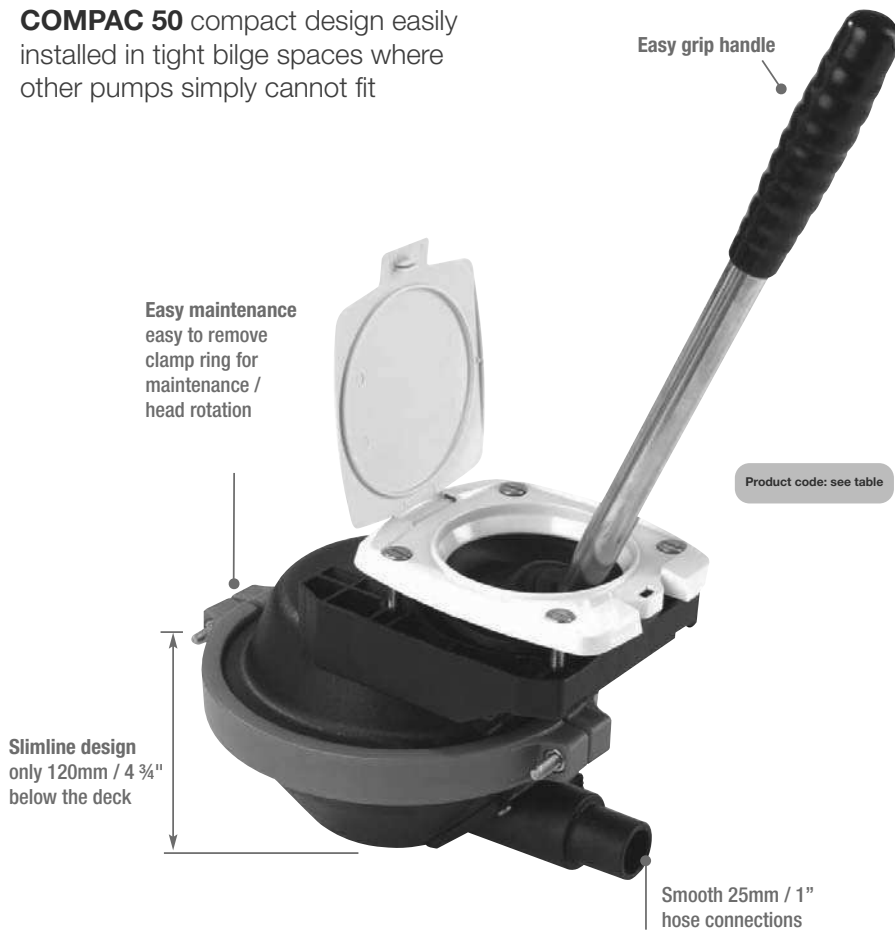

Features and Benefits

- Whale's most slim line design
- Includes sleek Whale deck plate with cover
- Tough proven reliable
- High performance (up to 35 ltrs / 9.2 US gals per min)
- Suitable for pumping bilge water saltwater or diesel

5 Year Warranty

Tips

It is important to ensure that a vented anti-siphon loop is incorporated in the system

Awards and Accreditations

- Suitable as a primary bilge pump on boats equal to or greater than 12 m (40 ft) accordance with ISO15083

COMPLETE YOUR SYSTEM

Whale high quality bilge accessories including non-return valves, elbows and Y pieces see page 40-43

i Product Information

Model Specifications

Model	Compac 50 Thru Deck / Bulkhead
Product Code	BP0350
Weight	0.9 kg (2 lbs)
Hose Connections	25 mm (1") Smooth Hose Connections
Materials	Pump Body: Glass-filled Polypropylene, Clamp Ring: Acetal Diaphragm, Valves and Seals: Nitrile®, Operating Lever: Glass-filled Nylon Gaiter: EPDM, Deck Plate Cover: PBT, Fasteners: Stainless Steel
Materials In Contact With Fluid	Glass-filled Polypropylene, Nitrile®, Stainless Steel
Service Kit	AK8035 - Service Kit for Compac 50 Contains: Diaphragm, Valves and Clips
Accessories	AS0353 - Clamping Ring Kit AS0355 Spare Handle / AS0356 - Deckplate Kit
Maximum Suction Lift	3 m (10 ft)
Maximum Discharge Head	4 m (13.5 ft)

Spares Kits

AK8035	Service Kit - Whale Compac 50 - diaphragm, valves and fixings
AS0352	Service Kit - Whale Compac 50 - Rocker Arm + Clamp Plate Kit
AS0353	Service Kit - Whale Compac 50 - Clamping Ring Kit
AS0355	Service Kit - Whale Compac 50 - Handle Assembly
AS0356	Service Kit - Whale Compac 50 - Deckplate Kit

Performance Data

Suction Lift	1 m (3 ft)
Discharge Head	0.5 m (1.5 ft)
45 Strokes per Minute	32 ltrs (9 US gals)
70 Strokes per Minute	35 ltrs (9.2 US gals)

Note: These specifications are retail items only.
For details of our bulk pack range for boat builders and wholesalers - contact Whale Support.

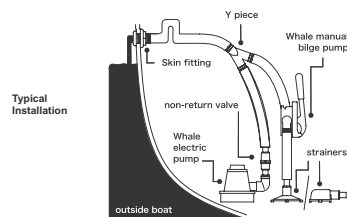
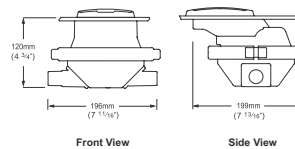

Whale's Compact Range

Smartbail

3 Year Warranty

Product code: see table



Whale's low profile compact range designed for confined spaces where you have limited space to fit your pump

Sleek integrated handle makes the pump instantly ready for use

Features and Benefits

- Trust Whale to make a smart pump
- The lightweight fast installation option
- Quick easy to install by one person
- Compact size is ideal where space is limited
- Modern styling
 - sleek cover blends in with the deck fibreglass
- Easy pump action - Patented diaphragm
- Self-sealing design means no need for messy sealants

Tips

It is important to ensure that a vented anti-syphon loop is incorporated in the system

Awards and Accreditations

- Suitable as a primary bilge pump on boats equal to or greater than 12m (40ft) in accordance with ISO15083

i

Product Information

Model Specifications

Model	Whale Smartbail (Thru Bulkhead)
Product Code	BP5012
Weight	0.6 kg (1.31lbs)
Hose Connections	2 options included: 25 mm ports (1") qty 2 38 mm ports (1 1/2") qty 2
Materials	Glass-filled Polypropylene, Stainless Steel, Nitrile®, Santoprene®
Materials In Contact With Fluid	Pump body: Glass-filled Polypropylene Inlet and outlet valves: Nitrile® Diaphragm: Santoprene®
Service Kit	AK5010 - Diaphragm, valves and seals

Performance Data

Maximum Head		3m (9.8ft)			
Maximum Lift		3m (9.8ft)			
Maximum Combined Head and Lift		3m (9.8ft)			
		BP5012 (with 25mm ports)		BP5012 (with 38mm ports)	
		Smartbail using 25 mm (1") ports		Smartbail using 38 mm (1 1/2") ports	
Lift	Head	45 Strokes/Min	70 Strokes/Min	45 Strokes/Min	70 Strokes/Min
0 m (0 ft)	0 m (0 ft)	38.5 ltrs/min (10.17 US gals/min)	60 ltrs/min (15.9 US gals/min)	43.5 ltrs/min (11.5 US gals/min)	67.7 ltrs/min (17.9 US gals/min)
1 m (3 ft)	1 m (3 ft)	32.75 ltrs/min (8.7 US gals/min)	51 ltrs/min (13.5 US gals/min)	43.5 ltrs/min (11.49 US gals/min)	67.7 ltrs/min (17.9 US gals/min)

Note: These specifications are retail items only.
For details of our bulk pack range for boat builders and wholesalers - contact Whale Support.

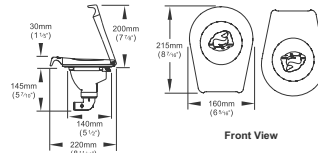

Typical Installation

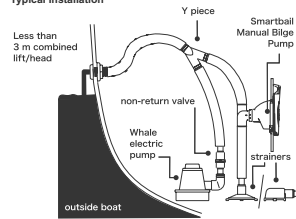

This product is protected by the following patents: United States Patent No. US 7,647,860; German Patent No. DE 602005024830.7-08 (EPI/DE) 1 792 082; French Patent No. FR 1 792 082; United Kingdom Patent No. GB 1 792 082 and Irish Patent No. IE 1 792 082; and by Australian Patent No. 2005 276232; and this product is also protected by the following patents and patent application: German Patent No. 602006021398.0 (EPI/DE) 1 846 688; French Patent No. FR 1 846 688; United Kingdom Patent No. GB 1 846 688; and Irish Patent No. IE 1 846 688; and by Australian Patent No. 2006 212431; and United States Patent Application No. 11/814,640.

Portable pumps - The handy hand pump for easy bail out!



Product code: see table

Ready to pump
1" / 25 mm hose
no fittings or
plumbing required

Easybailer

MANUAL BILGE

EASYBAILER the portable choice from Whale. Instantly ready for use

5 Year Warranty

Features and Benefits

Whale's hand held pump for easy bail out on board small boats dinghies/kayaks

- Portable light weight design
- Suitable for bilge water or diesel transfer
- Flexible hose can be easily directed to hard to reach bilge areas
- Available in two barrel lengths 483 mm (19") or 685 mm (26 15/16")

Awards and Accreditations

- Suitable as a primary bilge pump on boats up to 12m (40ft) in accordance with ISO15083

i Product Information

Model Specifications

Model	Short Barrel Version BP1935	Long Barrel Version BP1955
Product Code	BP1935	BP1955
Hose Connections	25 mm (1") Hose Connections	
Weight	0.32 kg (0.7 lbs)	0.4 kg (0.9 lbs)
Materials	Pump Body: ABS, HDPE, Polypropylene, PVC, uPVC, Diaphragm - Neoprene, Fasteners: Stainless Steel	
Materials In Contact With Fluid	ABS, HDPE, Polypropylene, PVC, uPVC, Neoprene, Stainless Steel	

Performance Data

	BP1935 / BP1955	BP1935 / BP1955
Suction Lift	0	1m (3 ft)
Discharge Head	0.5 m (1.5 ft)	0.5 m (1.5 ft)
4S Strokes per Minute	19 ltrs (5 US gals)	19 ltrs (5 US gals)
70 Strokes per Minute	31.4 ltrs (8.3 US gals)	31.4 ltrs (8.3 US gals)

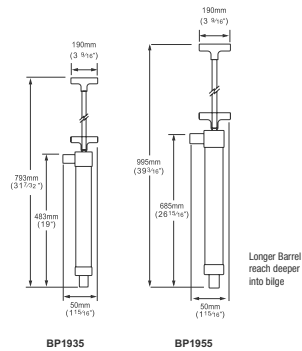

Side View

Bilge Accessories

Bilge Accessories

Complete Your System

Fit Whale® high quality pumps and accessories to ensure long term reliability throughout your bilge waste system. Whale switches, diverter valves, and pipework connections are designed and manufactured with highest quality at heart. Combine these accessories with your Whale bilge pumps for reliability and durability.

Need specific advice on your system? Contact our technical team at Whale support
See below for a full list of accessories

Electric Bilge Switches

NEW Electric Field Sensor Range

- Electric field sensor automatically sense water levels and switch on the bilge pumps
- Automatically switches on when 51mm (2") of water is sensed and turns off when water drops below 13mm (½")
- BE9006 model - built in 30 second off delay for efficient operation, prevents cycle in small sump installations or enables lower drain than 13mm (½")

Model Specifications

Model	Electric Field Sensor Switch BE9003	Electric Field Sensor Switch with time delay BE9006
Product Number	BE9003	BE9006
Voltage D.C.	12V d.c. or 24V d.c.	
Current	Suitable for up to 20 Amps	
Residual Current	0.008 Amp	

Suitable for Orca and Supersub standard submersible ranges – page 20 and 18

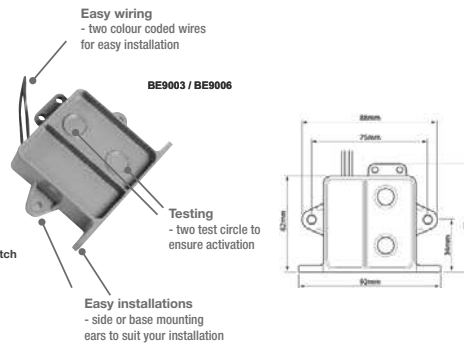

Float Switch

Floatswitch Ideal for use with Electric Bilge Pumps

- Environmentally friendly - no toxic mercury
- Easy to install mounted on either horizontal or vertical surface (e.g. bulkhead or hull)
- Suitable for installations where amp draw is up to 15 amps
- Compact design
- Can be used as a high water bilge alarm (when vertically mounted)

Model Specifications

Model	Whale Float Switch BE9002
Product No.	BE9002
Voltage D.C.	12V d.c. or 24V d.c.
Current	Suitable for up to 15 Amps

Suitable for Orca and Supersub Standard Submersible ranges see page 20 and 18

Note: These specifications are retail items only.
 For details of our bulk pack range for boat builders and wholesalers - contact Whale Support.

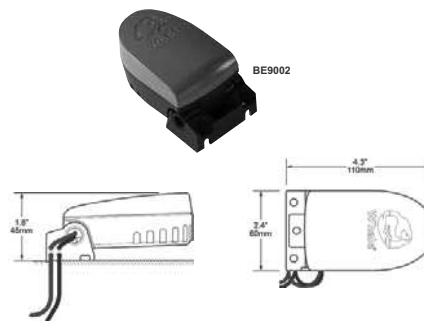

Accessories - Pipework Connections

Whale supply a wide range of accessories designed specifically for use with Whale Pumps, creating a system solution for the installer.

Y Piece

- Designed to enable two pumps to discharge through a single line
- Ideal for use when a diverter is not required

Model Specifications

Model Product Code	Y Piece YP6130	Y Piece YP6114
Pipe Diameter	12.5 mm (½")	38 mm (1½")
Materials	Acetal	Glass-filled Polypropylene



YP6130

YP6114

Elbows

- Ideal for use in installations in confined spaces

Model Specifications

Model Product Code	Elbow EB3364	Elbow EB3488
Pipe Diameter	25 mm (1")	38 mm (1½")
Materials	Glass-filled Polypropylene	



EB3364

EB3488

Non-Return Valves

- Provide an easy way to maintain prime in a suction or discharge line
- Designed to fit in-line
- Suitable for use with manual or electric pumps

Model Specifications

Model Product Code	Non-Return Valve LV1215	Non-Return Valve Barbed Connections LV1219
Pipe Diameter	25 mm (1") 38 mm (1½")	19 mm (¾") or 25mm (1")
Materials	Body: Glass-filled Polypropylene, Valve: Nitrile®	



LV1215

LV1219

Skin Fittings

- Manufactured in strong high quality moulded non-corrosive acetal

Model Specifications

Model Product Code	Skin Fitting SF5018	Skin Fitting SF5131	Skin Fitting SF5204	Skin Fitting SF5425
Diameter Size	16 mm (¾")	19 mm (¾")	25 mm (1")	38 mm (1½")
Materials	Acetal			



SF5204
(see table for part numbers of other hose connections)

Note: These specifications are retail items only.
For details of our bulk pack range for boat builders and wholesalers - contact Whale Support.

Bilge Accessories

Bilge Accessories

Deckplates

Deckplates

A Comprehensive Range Of Bilge Pump Covers

- Provides a neat cover over manual bilge pumps
- Aesthetic designs
- Manufactured from UV Stabilised plastic
- Will not fade or discolour
- Snap-shut lid remains closed when pump is not in use

Deckplate Selector			
Product Code	Model	Materials	For Use With
DP8904	Plastic 4 Hole Model	PBT	Gusher® Urchin Gusher® Titan, Gusher® 10
DP3804	Metal 4 Hole Model	Cast and Aluminum LM6	Gusher® 10 Gusher® 30 (BP3020)
DP9905	Plastic 6 Hole Deck Ring	Acetal	Mk 5 Underdeck BP0535/MH5560
DP9906	Plastic 4 Hole Covered Model	PBT	Mk5 Universal
AS0356	Plastic 4 Hole Model	PBT	Compac 50
AS3020	Includes DP3804+ Bridge Section	Cast and Aluminum LM6	Gusher® 30 (BP3020)

Note: These specifications are retail items only.
For details of our bulk pack range for boat builders and wholesalers - contact Whale Support.

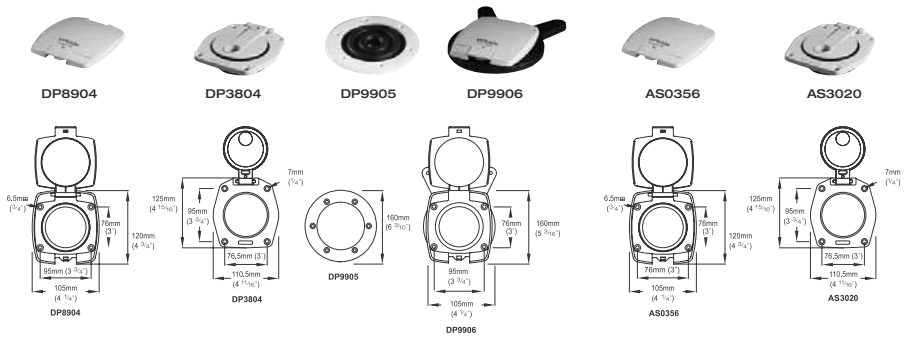

Diverter Valve

Diverter Valve

Allows one pump to draw from two locations

- Robust, reliable design
- Teflon® lubricated non-stick operation
- Precision machined for odour-proof seal
- Withstands sewage/black waste, saltwater and bilgewater
- Models available in either 25 mm (1") or 38 mm (1 1/2") hose connection

Typical Uses

- Suitable for electric or manual waste management systems
- Used in bilge and toilet waste systems
- Diverts flow to holding tank or overboard or deck pump out



Diverter Valve
5 Year Warranty

Model Specifications

Model	Diverter Valve	Diverter Valve
Product Code	DV5630	DV5606
Hose Connections	25 mm (1")	38 mm (1 1/2")
Materials	Main Body: Acetal, Teflon®, Handle: PTFE Polyester	

Allows one pump to draw from two locations

Note: These specifications are retail items only.
For details of our bulk pack range for boat builders and wholesalers - contact Whale Support.

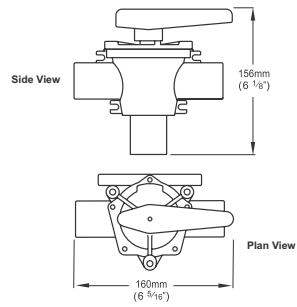

Bilge Strainers/Strum Boxes

Strainer

3/4" (19mm) Strainer with Multi-Directional Port and Non-Return Valve



SB3422
(Top/Side entry)

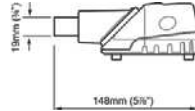

Side View

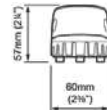

Front View

Strainer

1" (25mm) 1 1/2" (38mm) Strainers available with top or side entry

Model	Top Entry Strainer	Side Entry Strainer
Product Code	SB5865	SB4222
Materials	Polypropylene	



SB4222 **SB5865**

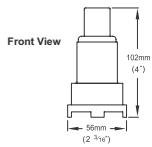

SB5865

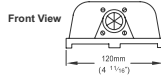
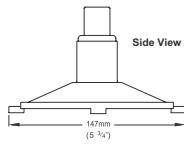

SB4222

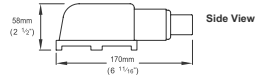



Whale - Fresh Water Range

For all your freshwater needs on board



Whale's wide range of freshwater pumps, plumbing and accessories offer you all you need for a smooth and constant freshwater supply on board from water supply to outlet. Our latest innovation the Fresh IC pump monitors the whole system to deliver high performance flow, ideal for a power shower (see page 46-47) Our range includes a variety of manual and electric pumps with various flow rates and pressure settings to best suit your boat. Our extensive range allows you to fit a complete Whale system from plumbing, pumps and filters to faucets and showers.

Electric Freshwater Galley Pumps

- **NEW** Fresh IC - Page 46-47
- Universal - Page 48-49
- Accumulator Kits - Page 50-51
- Submersible Impeller Pumps - Page 52-53
- Inline Booster Pumps - Page 54-55

Manual freshwater Galley Pumps

- Hand operated pumps - V pump - Page 56
- Hand operated pumps - Flipper - Page 57
- Foot operated pumps - Gusher Galley - Page 58
- Foot operated pumps - Babyfoot - Page 59
- Foot operated pumps - Tiptoe - Page 60

Faucets and Interior Showers

- ABS tough lightweight range - Elegance faucet range page 62-63 elegance shower range page 68
- Chromed brass - metal faucet range page 64-67, shower range page 69

Deck/ Transom Showers

- **NEW** Twist Deck shower - Page 70-71
- **NEW** Compact Swim 'n' Rinse range - Page 72-73
- Swim 'n' Rinse - Page 74-75

Accessories

Complete the system with filters, surge dampers, strainers, one way valves and pressure switches - Page 76-77

Fresh IC



NEW Fresh IC freshwater power shower pump with intelligent control built in

Prevents rapid cycling without sacrificing flow or performance

Award Winning Design



Please Note:
This is not VSD technology

This product is protected by the following granted patents: United States Patent No. US 6,840,745; Canadian Patent No. 2 380 465; United Kingdom Patent No. GB 1 222 392; French Patent No. FR 1 222 392; German Patent No. DE 60018089.1 (EP/DE 1 222 392); and Italian Patent No. IT 1 222 392.

Features and Benefits

- Fresh IC provides a consistent stabilised water system by monitoring flow, energy consumption and back pressure.
- Fresh IC provides 30% more flow and 45% more pressure in a typical shower than VSD pumps*
- The Fresh IC is specifically designed to offer premium flow and pressure in the shower, where you most want it.
- Intelligent Control ensures the pump only turns off when outlets are closed.

* Performance data from Whale in house laboratory versus typical competitors (July 2011)

1 Year Warranty

Awards and Accreditations

- DAME AWARD - Special Mention 2010
- Industry Approved IP65 Pump
- EMC compliant
- CE marked



COMPLETE YOUR SYSTEM

Freshwater system accessories such as water filters, and pipework connections – page 76-77

YOU MAY ALSO LIKE

- Whale water filters – page 76
- Whale Quick Connect plumbing - Pipework and fittings – page 84
- Bilge IC products - page 16
- Grey IC products - page 90-93

i Product Information



Model Specifications

Product Code	Fresh IC - Freshwater Pressure Pump	
	FW5082	FW5084
Voltage	12 V d.c.	24 V d.c.
Open flow rate/minute	13ltrs (3.4 US gals)	
Ingress Protection Rating	IP65	
Recommended Automotive Fuse Size	12 Amp	6 Amp
Minimum Wire Size	2.5 mm ² (13 AWG)	
Weight	2.95kg (6.6lbs)	
Static System Pressure	2.5 bar (36 psi)	
Maximum Running Pressure	4.4 bar (62psi)	
Hose Connections	Whale Quick Connect 15mm female. For 1/2" (13mm) flexible hose use WX1584 (supplied with retail kit)	
Materials	Pump Body: Glass-filled Polypropylene Motor Casing: Powder-coated Steel Feet, diaphragm & valves: Monoprene®, Santoprene® Seals: Nitrile®, Fasteners: Stainless Steel	
Materials in Contact with fluid	Glass-filled polypropylene, Monoprene®, Nitrile®, Stainless Steel, Santoprene®	
Service Kits	AK1319 - Replacement strainer (available separately)	

Note: For wiring advice on your installation please contact Whale Support.
These parts numbers are retail items only.
For details of our bulk pack range for boat builders and wholesalers - contact Whale Support.

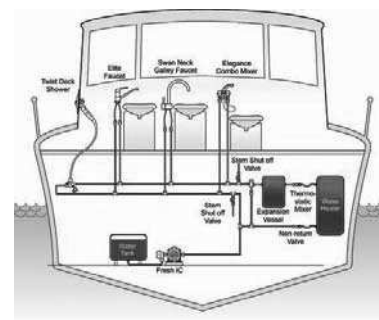
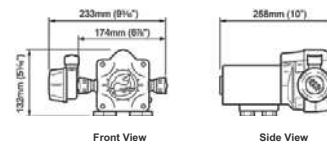

Typical Installation

Universal

Freshwater Pressure Pump Range

Delivers smooth constant water flow
runs dry without damage

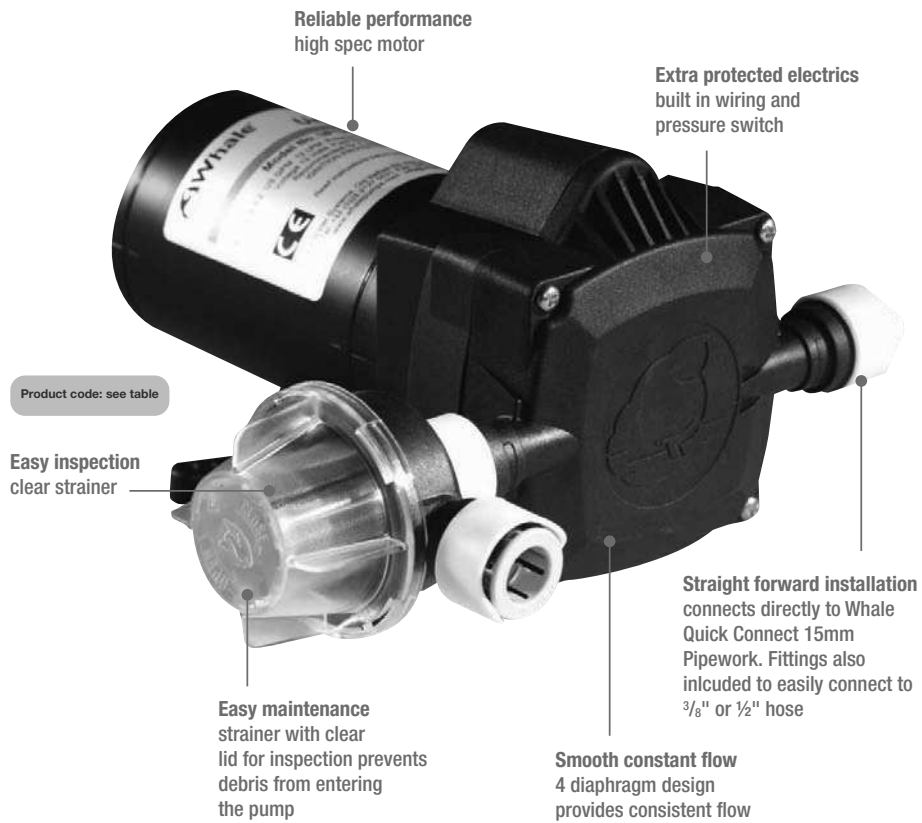

This product is protected by the following granted patents: United States Patent No. US 6,840,745; Canadian Patent No. 2 380 465; United Kingdom Patent No. GB 1 222 392; French Patent No. FR 1 222 392; German Patent No. DE 60018089.1 (EP/DE) 1 222 392; and Italian Patent No. IT 1 222 392.

Features and Benefits

WHY Universal?

- Runs dry without damage
- Self-priming up to 3 m (10 ft)
- Smooth constant flow
- Quiet operation
- Extra protection and safety with wires and pressure switch housed internally
- Adaptors included to install directly to 1/2" / 3/8" hose connections
- Universal mounting arrangement fits any existing installation
- Suitable for use with saltwater and freshwater
- Easy installation - suitable for 15 mm Quick Connect plumbing direct connection

2 Year Warranty

Awards and Accreditations

- EMC compliant
- CE marked
- ISO8846

COMPLETE YOUR SYSTEM

Freshwater system accessories such as water filters, surge dampers and pipework connections – page 76-77

YOU MAY ALSO LIKE

- Whale water filters – page 76
- Fresh IC freshwater power shower pump with intelligent control built in - page 46
- Whale Quick Connect plumbing - Pipework and fittings – page 84-87

FRESHWATER

Product Information

Model Specifications

Model	8 ltrs (2.2 US gals)					12 ltrs (3.2 US gals)			18 ltrs (4.75 US gals)	
	Model		Model			Model		Model		
Product Code	UF0812	UF0815	UF1212	UF1214	UF1215	UF1225	UF1815	UF1825		
Open Flow Rate per Minute	8 ltrs (2.2 US gals)		12 ltrs (3.2 US gals)				18 ltrs (4.75 US gals)			
Voltage	12 V d.c.					24 V d.c.	12 V d.c.	24 V d.c.		
Recommended Fuse Size	5 amp		8 amp			4 amp	12 amp	8 amp		
Weight	2.4 kg (5.3 lbs)						2.9 kg (6.4 lbs)			
Hose Connections	Whale Quick Connect 15 mm Female For 1/2" Flexible Hose Use WX1584 (supplied with pump) For 3/8" Flexible Hose Use WU1215 + WU1280 (not supplied with pump)					3/4" Male Threaded Connections				
Connection to Quick Connect 15 mm Plumbing	NO ADAPTOR REQUIRED For Other Systems - Contact Whale					For Whale Quick Connect 15 mm Use WX1542 (not supplied with pump)				
Additional Fittings	1/2" BSP Male Adaptors WX1587 x 2 (supplied with pump) 1/2" Flexible Hose Adaptors WX1584 x 2 (supplied with pump)					3/4" Flexible Hose Adaptors x 2 (supplied with pump)				
Minimum Wire Size	2.5 mm ² (13 AWG)									
Out Out Pressure	1 bar (15 psi)	3 bar (45 psi)	1 bar (15 psi)	2 bar (30 psi)	3 bar (45 psi)					
Materials	Pump Body: Glass-filled Polypropylene, Motor Casing: Aluminium, Power-coated Steel Diaphragm, Valves, Feet: Monprene®, Seals: Nitrile®, Fasteners: Stainless Steel									
Materials in Contact With Fluid	Glass-filled Polypropylene, Monprene®, Nitrile®, Stainless Steel									
Service Kits	AK1316 - Replacement Head		AK1317 - Microswitch			AK1319 - Replacement Strainer				
Maximum Suction Lift	3 m (10 ft)									
Maximum Discharge Head	10 m (33 ft)	30 m (98 ft)	10 m (33 ft)	20 m (66 ft)	30 m (98 ft)					

Note: These specifications are retail items only.
For details of our bulk pack range for boat builders and wholesalers - contact Whale Support.

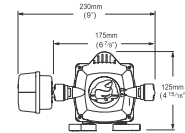
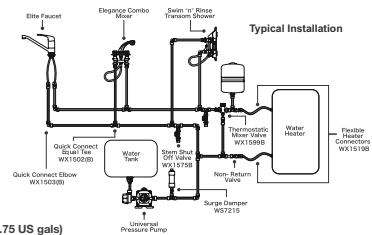

Front View

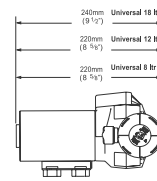

Side View

Pump Accumulator Kit – Integrated

**Smooth constant flow -prevents water hammering and cycling.
One piece kit includes pump and 8 ltr compact accumulator tank.**

This integrated kit is a drop into line pre-assembled kit designed to provide a constant reliable flow of water on board.

Save time and money fast installation

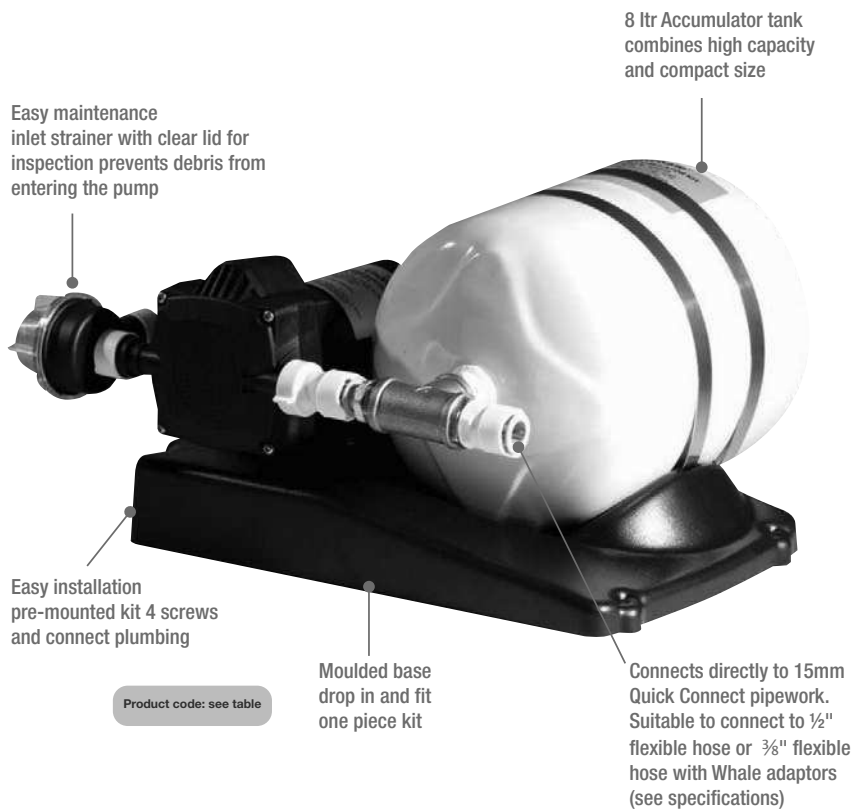

Features and Benefits

- Combined pump and accumulator tank ensures a smooth even flow of water to all outlets
- Compact design installs easily in convenient locations
- Reduced noise and vibration by preventing pump cycling
- Easily plumbed into standard 1/2" or 3/8" pipework
- Connects directly to Whale Quick Connect 15 mm plumbing system
- Can be fitted to new or existing systems
- Includes long life Whale pressure pump

2 Year Warranty

Approvals and Standards

- EMC compliant
- CE marked

COMPLETE YOUR SYSTEM

Freshwater system accessories such as water filters, and pipework connections – page 76-77

YOU MAY ALSO LIKE

Whale water filters – page 76

Fresh IC freshwater power shower pump with intelligent control built in- page 46

Whale Quick Connect plumbing - Pipework and fittings – page 84-87

Product Information

Model Specifications

Model	Accumulator Kits			
	Includes UF1214	Includes UF1215	Includes UF1825	Includes UF1815
Product Code	UF2014	UF2015	UF8025	UF8015
Accumulator Tank Size	8 ltrs (2.2 US gals)			
Open Flow Rate per Minute	12 ltrs (3.2 US gals)		18 ltrs (4.75 US gals)	
Voltage	12 V d.c.	12 V d.c.	24 V d.c.	12 V d.c.
Recommended Fuse Size	8 amp	8 amp	8 amp	12 amp
Weight	5.4 kg (11.9 lbs)		5.9 kg (13 lbs)	
Hose Connection	Whale Quick Connect 15 mm Female For 1/2" Flexible Hose, Use WX1584 (supplied with kit) For 3/8" Flexible Hose, Use WJ1215 and WJ1280 (not supplied with kit)			
Connections to Quick Connect 15 mm	NO ADAPTORS REQUIRED		WX1542 (not supplied with kit)	
Additional Fittings	WX1587 x 2 - 1/2" BSP Male Adaptors (supplied with kit)		2 x 3/4" Flexible Hose Adaptors (supplied with kit)	
Minimum Wire Size	2.5 mm (13 AWG)			
Out Out Pressure	2 bar (30 psi)		3 bar (45 psi)	
Materials	Pump Body: Glass-filled Polypropylene Aluminium and Powder-coated Steel Diaphragms, Valves and Feet: Monoprene®, Seals: Nitrile®, Tank: Butyl, Base: ABS Fittings: Brass, Fasteners: Stainless Steel			
Materials in Contact With Fluid	Glass-filled Polypropylene, Monprene®, Nitrile®, Stainless Steel, Brass			
Factory Pre-charge Pressure +/-0.014 bar +/-2psi	1.4 bar (20 psi)		2.2 bar (32 psi)	
Maximum Suction Lift	3 m (10 ft)			
Maximum Discharge Head	20 m (66 ft)		30 m (98 ft)	

Note: These specifications are retail items only.
For details of our bulk pack range for boat builders and wholesalers - contact Whale Support.

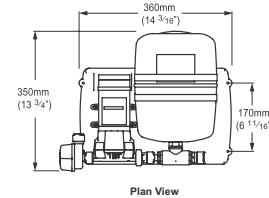
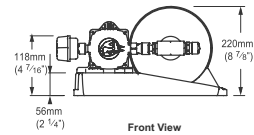

Submersible Impeller Range

Whale's high flow long life submersible impeller galley pumps

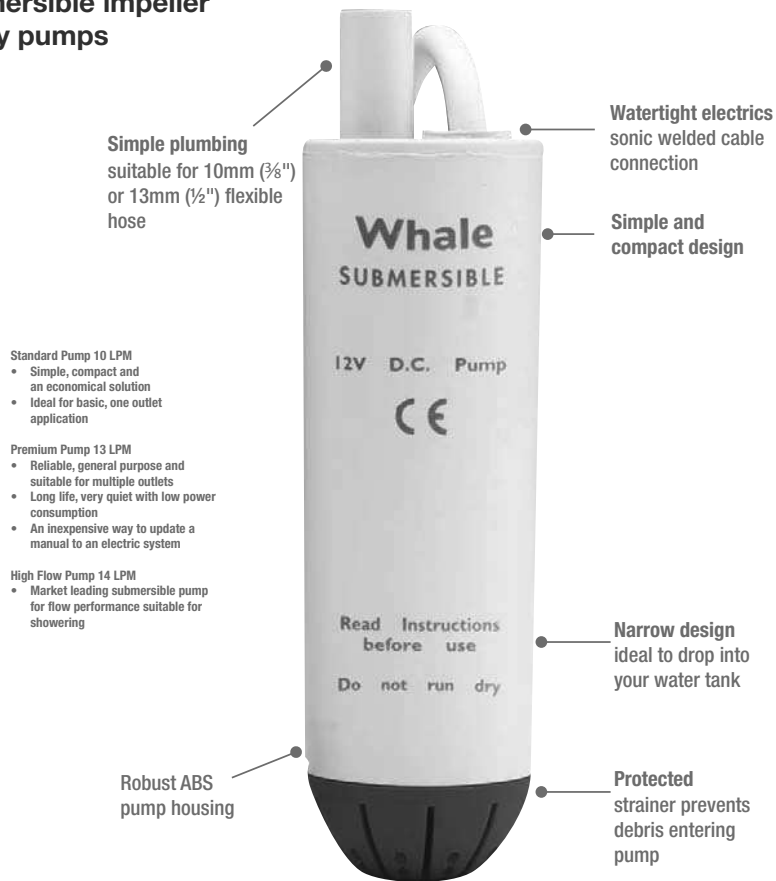

Product code: see table

Features and Benefits

- Simple, compact economical solution
- Long life, very quiet with low power consumption
- An inexpensive way to update a manual to an electric system
- Choose the pump to suit your freshwater needs on board from 3 flow options
- 12 V d.c. / 24 V d.c. models available
- Compact, quiet, lightweight design suitable for use with pressure switch and microswitch systems
- Also suitable for pumping diesel

1 Year Warranty

Awards and Accreditations

- EMC compliant
- CE marked

COMPLETE YOUR SYSTEM

Freshwater system accessories such as water filters, and pipework connections – page 76-77

YOU MAY ALSO LIKE

- Whale water filters – page 76
- Fresh IC freshwater power shower pump with intelligent control built in- page 46
- Universal Pressure Pumps – page 48
- Whale Quick Connect plumbing - Pipework and fittings – page 84-87

i Product Information

Model Specifications

Model	Standard		Premium		High Flow	
	12V d.c.	12V d.c.	12V d.c.	24V d.c.	12V d.c.	12V d.c.
Pump	Sub	Sub	Inline	Sub	Inline	Sub Inline
Submersible Pump Old Code	GP1002	GP8815	GP9955	GP8825	GP9965	GP9216 GP9255
Submersible Pump New Code	GP1002	GP1352	GP1392	GP1354	GP1394	GP1652 GP1692
Fuse Size	5 amp automotive			3 amp automotive		5 amp automotive
Weight	0.15kg (0.3 lbs)					
Hose Connections	Suitable for 10 mm (3/8") or 13 mm (1/2") Flexible Hose					
Connection to Quick Connect Plumbing	Use WX1511B (Stem Adaptor 11 mm-15 mm) Connect WX1504 (15 mm Equal Straight) see page 84-87					
Materials in contact with liquid	Pump Body: ABS, Seals: Nitrile®, Strainer: Polypropylene, Impeller: PBT, Cable: PVC					

Note: Each pump performance will depend on the plumbing system and restrictions on outlets in your boat.
Note: New Model codes are direct replacement for pre 2006 model part numbers.

Performance Data

Model	Flow Rate Per Minute / Current Draw			
	Standard 12V d.c.	12 V d.c. Premium	24V d.c.	High Flow 12V d.c.
0 m (0 ft)	10.3 ltrs 2.4 amps	13.2 ltrs 3.6 amps	13.2 ltrs 1.8 amps	15.8 ltrs 3.8 amp
1 m (3 ft)	8.75 ltrs 2.2 amps	11.75 ltrs 3.3 amps	11.75 ltrs 1.6 amps	14.8 ltrs 3.7 amps
3 m (9 ft)	5.75 ltrs 2.0 amps	9.75 ltrs 2.9 amps	9.75 ltrs 1.45 amps	12.8 ltrs 3.5 amps

Note: Each pump performance will depend on the plumbing system and restrictions on outlets in your boat.

Dimensions Table

	A	B	C	D
Standard	20 mm (3/16")	88 mm (3 7/16")	36 mm (1 1/8")	108 mm (4 1/4")
Premium/High Flow	20 mm (3/16")	109 mm (4 3/16")	36 mm (1 1/8")	129 mm (5 1/16")

Note: These specifications are retail items only.
For details of our bulk pack range for boat builders and wholesalers - contact Whale Support.

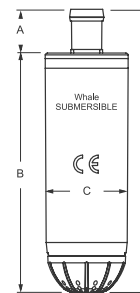

WARNING
Note: Not suitable for petrol, low flash point liquids and aggressive chemicals.
This pump must not be used for pumping petrol or any highly inflammable or corrosive liquids.

In-Line Booster Pump

Whale's highest flow rate, longest life in line impeller galley pumps
- fit in line to increase flow rate

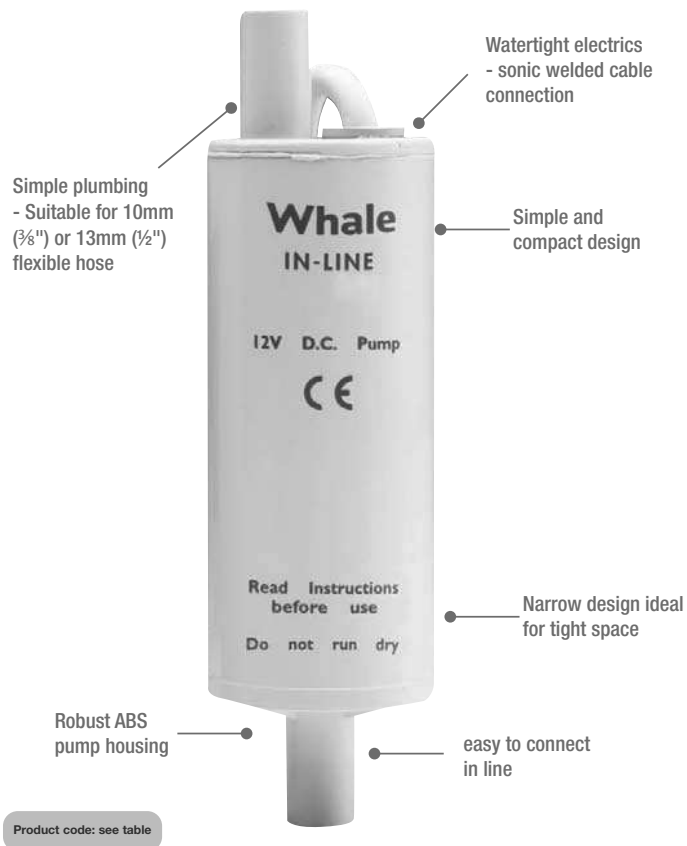

Features and Benefits

Compact Electric In-Line Pump

- Simple, compact and an economical solution
- Long life, very quiet with low power consumption
- An inexpensive way to enhance your water system on board
- Choose the pump to suit your freshwater needs on board from 2 flow options
- Lightweight design
- Ideal for pumping freshwater and saltwater
- Straight forward installation - fits unsupported into pipework
- Available in 12 and 24 V d.c. models

1 Year Warranty

Approvals and standards

- EMC compliant
- CE marked

COMPLETE YOUR SYSTEM

Freshwater system accessories such as water filters, and pipework connections – page 76-77

YOU MAY ALSO LIKE

Fresh IC freshwater power shower pump with intelligent control built in- page 46

Universal Pressure Pumps – page 48

Whale Quick Connect plumbing - Pipework and fittings – page 84-87

Whale's manual galley foot pump range – Gusher Galley – page 58, Tiptoe – page 60, Babyfoot- page 59

Product Information

Model Specifications

Model	In-Line Premium	In-Line Premium	In-Line High Flow
Product Code	GP1392	GP1394	GP1692
Voltage	12 V d.c.	24 V d.c.	12 V d.c.
Recommended Fuse Size	5 amp automotive	3 amp automotive	5 amp automotive
Weight	0.15 kg (0.3 lbs)		
Hose Connections	Suitable for 10 mm (3/8") or 13 mm (1/2") Flexible Hose		
Connection to Quick Connect Plumbing	Use WX1511B (Stem Adaptor 11 mm-15 mm) Connect WX1504 (15 mm Equal Straight) see page 84-87 and then 15 mm Plumbing		
Materials	Pump Body: ABS, Seal: Nitrile®, PBT		

Performance Data

Discharge Head	Flow Rate Per Minute		
0 m (0 ft)	13.2 ltrs	13.2 ltrs	15.75 ltrs
	3.6 amps	1.8 amps	3.8 amps
1 m (3 ft)	11.75 ltrs	11.75 ltrs	14.75 ltrs
	3.3 amps	1.6 amps	3.7 amps
3 m (9 ft)	9.75 ltrs	9.75 ltrs	12.75 ltrs
	2.9 amps	1.45 amps	3.5 amps

Note: Each pump performance will depend on the plumbing system and restrictions on outlets in your boat.

Note: These specifications are retail items only.

For details of our bulk pack range for boat builders and wholesalers - contact Whale Support.

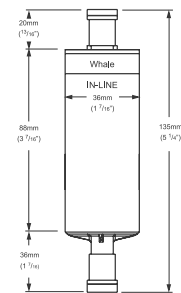

WARNING
Note: Not suitable for petrol, low flash point liquids and aggressive chemicals. This pump must not be used for pumping petrol or any highly inflammable or corrosive liquids.

Manual Freshwater Galley Pumps

V Pump Mk 6

5 Year Warranty

Narrow mounting base allows installation for use between two sinks

Features and Benefits

Whale manual self priming galley pumps simple hand operated solution for pumping water in the galley

- Ideal where space is limited
- Angled spout and adjustable height provide various options for installation
- Extended spout makes for easy filling of containers
- Capacity 8 ltrs (2.2 US gals) per minute
- Delivers a smooth flow on each stroke
- Useful as a back-up pump or for a simple freshwater supply pump
- Suitable for fresh water and saltwater
- Ideal where space is limited



COMPLETE YOUR SYSTEM

Freshwater system accessories such as water filters, and pipework connections – page 76-77

YOU MAY ALSO LIKE

- Whale water filters – page 76
- Fresh IC freshwater power shower pump with intelligent control built in- page 46
- Universal Pressure Pumps – page 48

Product Information

Model Specifications	
Model	V Pump Mk 6
Product Code	GP0650
Hose Connections	Suitable for Quick Connect 15 mm Plumbing and 13 mm (1/2") Flexible Hose
Weight	0.26 kg (0.6 lbs)
Materials	Pump Body: Acetal, Pump Barrel: Anodized Aluminium Alloy Seals: Neoprene, Nitrile®, Fasteners: Stainless Steel
Service Kit	AK0618 - Service Kit for V Pump, Mk 5, Mk 6 Models Contains: Diaphragm, Seals, Fasteners AS0627 - Clamping Block Assembly
Maximum Suction Lift	3 m (10 ft)
Maximum Discharge Head	4 m (13 ft)
Maximum Output per Minute	8 ltrs (2.2 US gals)

Note: These specifications are retail items only.
For details of our bulk pack range for boat builders and wholesalers - contact Whale Support.

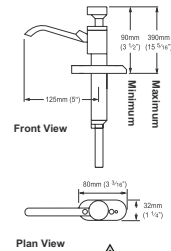

WARNING
Note: Not for use in pressurized systems

Manual Freshwater Galley Pumps



Flipper Pump Mk 4

FRESHWATER

Whale manual self priming galley pumps
Simple hand operated solution for pumping water in the galley

COMPLETE YOUR SYSTEM

Freshwater system accessories such as water filters, and pipework connections – page 76-77

YOU MAY ALSO LIKE

Whale water filters – page 76
Fresh IC freshwater power shower pump with intelligent control built in – page 46
Universal Pressure Pumps – page 48

i Product Information

Features and Benefits

- Ideal for installing between two sinks - swivelling outlet
- Fine flow control
- Easy operation - Light back & forth pump action
- 7 ltrs capacity (1.85 US gals) per minute
- Fine flow control
- Suitable for fresh or saltwater

Model Specifications

Model	Flipper Pump Mk 4
Product Code	GP0418
Hose Connections	Suitable for 13 mm (1/2") Flexible Hose
Weight	0.30 kg (0.71 lbs)
Materials	Pump Body: Acetal, Nylon, Polystyrene, Polypropylene LM6 Aluminium Alloy, Brass Seals: Neoprene, Nitrile®, ABS Fasteners: Stainless Steel
Service Kit	AK0405 - Service Kit for Flipper Mk3 and Mk4 Models Contains: Diaphragm, Seals, Screws AS0406 - Flipper Overhaul Kit
Maximum Suction Lift	3 m (10 ft)
Maximum Discharge Head	3 m (10 ft)
Maximum Output per Minute	7 ltrs (1.85 US gals)

Note: These specifications are retail items only.
For details of our bulk pack range for boat builders and wholesalers - contact Whale Support.

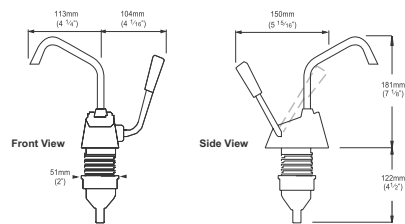

WARNING
Note: Not for use in pressurized systems

Manual Freshwater Galley Pumps

5 Year Warranty

Gusher® Galley

The simple solution for fresh water delivery in small galleys

Features and Benefits

Whale manual self priming galley pumps - simple foot operated solution for pumping water in the galley

- Smooth double action
- Self primes and operates dry without damage
- Easy, smooth hands free operation
- Ease of installation - Multi-directional inlet and outlet hose connections
- 3 mounting options (including thru bulkhead)
- Left and right oriented foot lever versions available
- Also ideally used to prime Whale In-Line Booster pumps
- Pumps fresh and salt water
- 15 ltrs (4 US gals) per minute

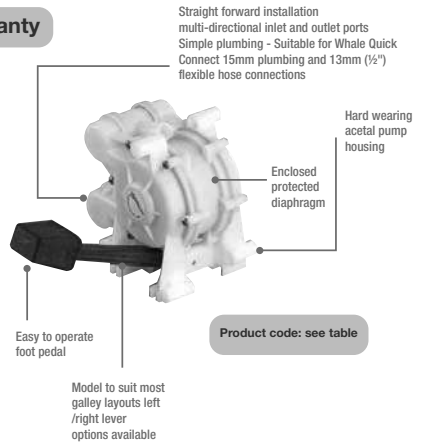

COMPLETE YOUR SYSTEM

Freshwater system accessories such as water filters, and pipework connections – page 76-77

YOU MAY ALSO LIKE

- Whale water filters – page 76
- Whale inline booster pumps to fit with Gusher Galley – page 54
- Fresh IC freshwater power shower pump with intelligent control built in- page 46
- Universal Pressure Pumps – page 48

Product Information

Model Specifications

Model	Gusher® Galley Mk 3	
Product Code	GP0550	GP0551
Lever Mounting	Right	Left
Weight	0.7 kg (1.5 lbs)	
Hose Connections	Suitable for Connection to Whale Quick Connect 15 mm Plumbing 13 mm (1/2") Flexible Hose	
Materials	Pump Body: Acetal, Nylon. Lever: LM6 Aluminium Alloy Diaphragm: Nitrile®, Neoprene, Fasteners: Stainless Steel	
Service Kit	AK0553 - Service Kit for Gusher® Galley (suitable for Mk 3 only) Contains: Diaphragm, Valves and Seals AS0556 - Piston and Operating Kit	
Maximum Suction Lift	2 m (7 ft)	
Maximum Discharge Head	3 m (10 ft)	
Maximum Output per Minute	15 ltrs (4 US gals)	

Note: These specifications are retail items only.
For details of our bulk pack range for boat builders and wholesalers - contact Whale Support.

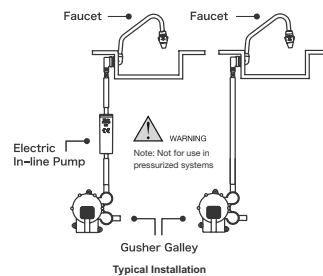
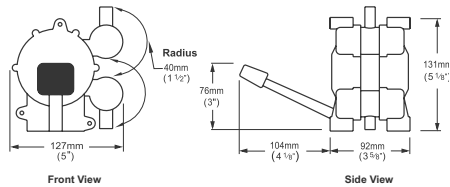

5 Year Warranty

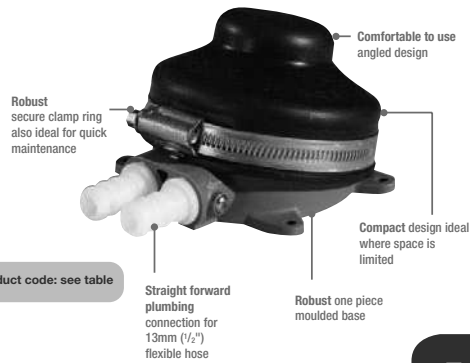

Product code: see table

COMPLETE YOUR SYSTEM

Freshwater system accessories such as water filters, and pipework connections – page 76-77

YOU MAY ALSO LIKE

Whale inline booster pumps to fit with Babyfoot – page 58
 Fresh IC freshwater power shower pump with intelligent control built in - page 46
 Universal Pressure Pumps – page 48

Manual Freshwater Galley Pumps

Babyfoot®

FRESHWATER

Self-priming foot pump designed for easy installation and use

Features and Benefits

Why Babyfoot?

Whale manual self priming galley pumps- simple foot operated solution for pumping water in the galley

- Smooth and easy operation
- Comfortable to use - angled top section
- Compact for installing in confined spaces
- Ideal as a priming pump for use with Whale in line impeller electric pumps
- The ideal foot pump for a simple freshwater system

i Product Information

Model Specifications

Model	Babyfoot®
Product Code	GP4618
Hose Connections	Suitable for 13 mm (1/2") Flexible Hose
Weight	0.3 kg (0.7 lbs)
Materials	Pump Body: Nylon, Ports: Acetal, Seals: Neoprene Fasteners: Stainless Steel, Phosphor Bronze
Service Kit	AK4615 - Service Kit for Babyfoot® Pump Contains: Diaphragm Valves, O Rings, Spring, Fasteners
Maximum Suction Lift	1.5 m (5 ft)
Maximum Discharge Head	3 m (10 ft)
Maximum Output per Minute	8 ltrs (2.2 US gals)

Note: These specifications are retail items only.
 For details of our bulk pack range for boat builders and wholesalers - contact Whale Support.

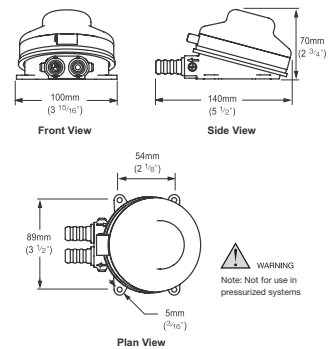

Manual Freshwater Galley Pumps

Tiptoe Pump Mk 4

Self priming foot pump that safely and discreetly fits flush to floor when not in use

Foot pump with smooth operation

5 Year Warranty

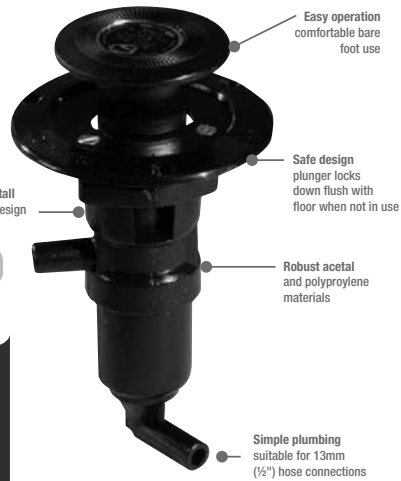

Product code: see table

Features and Benefits

Why Tiptoe?

Whale manual self priming galley pumps - simple foot operated solution for pumping water in the galley

- Easy, smooth action
- Designed for neat, through-floor mount
- Plunger locks down flush with the floor when not in use
- Comfortable for bare foot use
- 7 ltr (1.85 US gals) / minute capacity
- Suitable for fresh or salt water
- Ideal as a priming pump for use with Whale inline electric impeller pumps

COMPLETE YOUR SYSTEM

Freshwater system accessories such as water filters, and pipework connections – page 76-77

YOU MAY ALSO LIKE

Whale water filters – page 76

Whale inline booster pumps to fit with Tiptoe – page 54

Fresh IC freshwater power shower pump with intelligent control built in- page 46

Universal Pressure Pumps – page 48

Product Information

Model Specifications

Model	Tiptoe
Product Code	GP1309
Hose Connections	Suitable for 13 mm (1/2") Flexible Hose
Weight	0.4 kg (0.9 lbs)
Materials	Pump Body: Acetal, Nylon, Polypropylene Seals: Neoprene, Nitrile®, Phosphor Bronze, Fasteners: Stainless Steel
Service Kit	AK1304 - Service Kit for Tiptoe Mk 3 and Mk 4 Models Contains: Washers, Valve Plates, Circlips
Maximum Suction Lift	2 m (7 ft)
Maximum Discharge Head	4 m (12 ft)
Maximum Output per Minute	7 ltrs (1.85 US gals)

Note: These specifications are retail items only.
For details of our bulk pack range for boat builders and wholesalers - contact Whale Support.

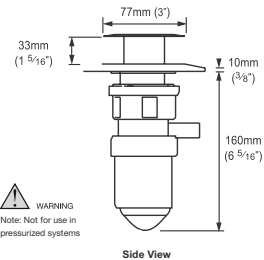

Whale - Faucets, Interior Showers and Deck or Transom Showers

For all your freshwater needs on board



Our extensive marine grade range of faucets and showers ensure that there is a model to suit your boat. The range includes lightweight ABS faucets, high polished chrome finish models, compact and telescopic ranges all in a wide range of outlets. From galley to vanity through to wetbar and deck / transom washdown whale high quality faucets and showers are all manufactured to the highest standards.

The award winning Whale Twist® is a radical innovation in deck shower design with a patented handset with integrated flow and temperature control and innovative housings designed to be quickly and easily fitted where space is limited.

Faucets and Interior Showers

- ABS tough lightweight Range - Elegance faucet range - Page 62-63
- Elegance shower range - Page 69
- Chromed brass - metal faucet range - Page 64-67, shower range - Page 68

Deck/ Transom Showers

- NEW Twist Deck shower - Page 70
- NEW Compact Swim 'n' Rinse range - Page 72
- Swim 'n' Rinse - Page 74

Accessories

- See Freshwater accessories to complete the system - Page 76-77

High Quality Faucet and Shower Range

Elegance Faucet Range

Lightweight and durable ABS faucets

Ideal for tight spaces

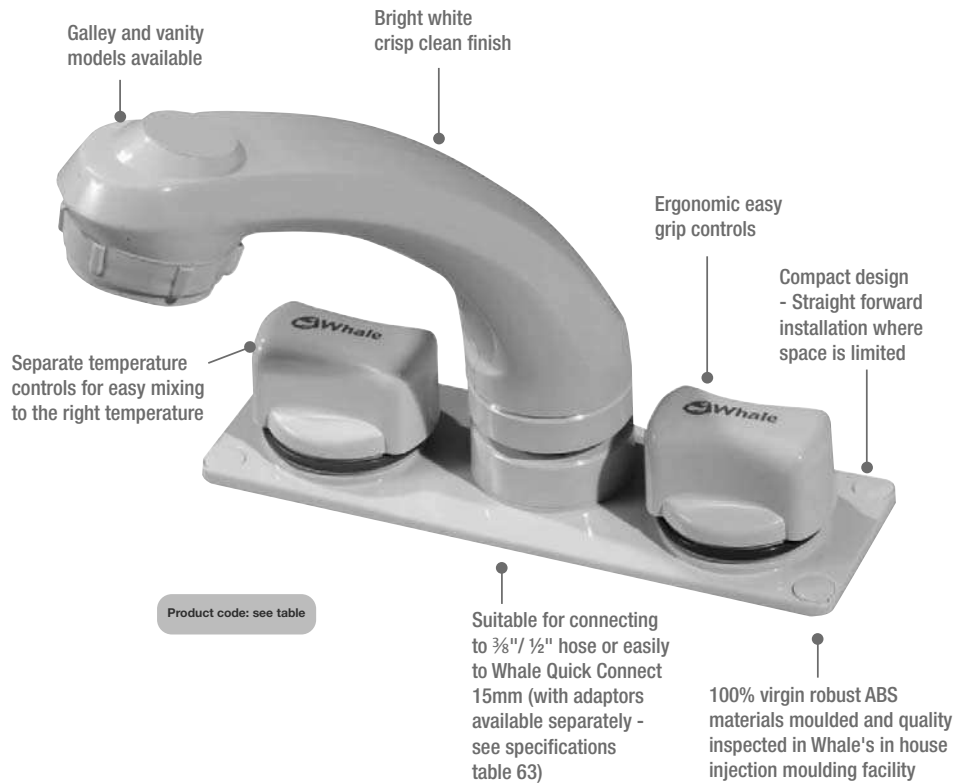

Features and Benefits

- Robust ABS construction
- Designed for use with all types of galley pumps
- Easily connects to Whale Quick Connect 15 mm pipework to either 3/8" or 1/2" hose connections
- Standard and extended spout models available
- Choice of single or mixer faucets
- Over 30 years experience - designed, refined and made in our UK facility since the early 1980s

1 Year Warranty

COMPLETE YOUR SYSTEM

Freshwater system accessories such as water filters, and pipework connections – page 76-77

YOU MAY ALSO LIKE

Whale Twist® - Deck Shower with integrated Temperature and Flow Controls – page 70

Swim 'n' Rinse- deck shower – The classic transom Shower – page 74

Fresh IC freshwater power shower pump with intelligent control built in- page 46

Whale chromed brass Faucets and showers – page 64 and 69



RT1210
Elegance - Cold Only
1 Year Warranty



RT2210
Elegance - Mixer Standard Outlet
1 Year Warranty

i Product Information

Model Specifications

Models - Retail	RT1210	RT2210
Description	Single Faucet Cold Only	Mixer Faucet Standard Outlet
Colour	White	
Hose Connections	1/2" Threaded	
Materials in Contact With Fluid	Body: ABS, Spout and Valves: Acetal, Seals: Neoprene	
Base Plate (mm)	113 x 55 (4 7/16" x 2 1/8")	171 x 62 (6 3/4" x 2 1/2")
Depth Beneath Surface	60 mm (2 3/8")	
Connection to Quick Connect 15 mm	WX1532	WX1532
Connection to 13 mm (1/2") Flexible Hose	WX1532 WX1584B	WX1532 WX1584B

Note: These specifications are retail items only.

For details of our bulk pack range for boat builders and wholesalers - contact Whale Support.

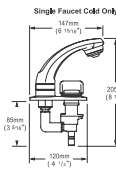

Front View

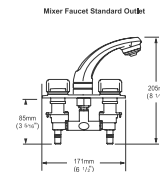

Front View

Metal Faucet Range

High quality polished chromed brass faucet range - 3 ranges

- **Modern Scandinavian style faucets**
- high quality chrome finish and modern styling - see page 65
- **Compact Range**
Make the most of your space on board with these slim - see page 66
- line faucets
- **Telescopic Range - Ideal for tight spaces** - see page 65



Features and Benefits

- High quality chromed brass polished finish - high shine finish
- Easy to use single lever swivel to adjust temperature and flow
- 100% marine grade materials
- Ease of Maintenance - high quality Ceramic valves in mixer units
- Easy connection into 1/2" pipework / Quick Connect 15 mm pipework

1 Year Warranty

COMPLETE YOUR SYSTEM

Freshwater system accessories such as water filters, and pipework connections – page 76-77

YOU MAY ALSO LIKE

Whale Twist® - Deck Shower with integrated Temperature and Flow Controls – page 70

Swim 'n' Rinse – deck shower – The classic transom Shower – page 74

Fresh IC freshwater power shower pump with intelligent control built in - page 46

Elegance – lightweight ABS faucet and shower range 62

Whale showers – page 68

i Product Information

Description	Galley Cold Only	Pull Out Galley	Galley Mixer	Vanity Mixer	Shower Mixer	Washdown bib/spigot	Wet bar		Bait station
							cold	mixer	
Domestic scandinavian style single lever faucets									
TT1111 Single Lever Galley mixer (chrome)									
TT1211 Single Lever mixer (chrome) –Swan Neck Galley									
TT1311 Single lever mixer - Vanity (chrome)									
TT1411 Single Lever Shower mixer (chrome)									
TT4180B Compact Range - Pull Out galley mixer (chrome)									
TT8011 Shower Handset - riser rail and hose (chrome)									
Tuckawayand Telescopic Faucet Range									
FT1276 Tuckaway Faucet angled with on/off control									
FT1160 Telescopic Faucet with on / off control									
FT1152 Telescopic control (outlet only)									
Compact faucet range									
TB4110 Compact Range - Single faucet cold only with valve (chrome)									
TB4112 Compact Range - Mixer Faucet									
TT4180B Compact Range - Pull Out galley mixer (chrome)									
TB4172 Compact range - washdown bib/ spigot									
TB4170 Compact Range - Washdown trigger handset									

Notes: TT models - come with 1 swivelling mixer faucet, Supplied with 1/2" BSP faucet tails and Securing Kit: Rubber C washer, metal C clamp, threaded bar with nut and sealing O ring
 Compact TB range - comes with 1/2" threaded connections (connection to 15mm Whale Quick Connect Plumbing = use WX1532 adaptor 1/2" BSP)
 Tuckaway / Telescopic FT Models - 1/2"/ 13mm connections - suitable only for non-pressurized systems
 NOTE: These specifications are retail items only. For details of our bulk pack range for boat builders and wholesalers - contact Whale Support

High Quality Faucet and Shower Range

Metal Faucet Range

Compact Range

Make the most of your space on board with these slim-line faucets



TB4112



TB4110

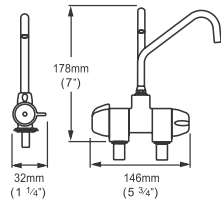

TB4112

Side View

Front View

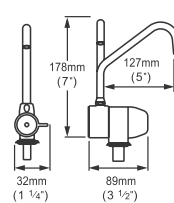

TB4110

Side View

Front View

High Quality Polished Chromed Brass Faucet Range

Modern Scandinavian - modern styling

FRESHWATER



TT1111
Lever Galley
Chrome Faucet
2 Year Warranty

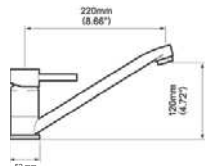

Lever Galley Chrome Faucet
TT1111



TT1311
Vanity
Chrome Faucet
2 Year Warranty

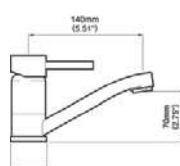

Vanity Chrome Faucet
TT1311



TT1211
Swan Neck Galley
Chrome Faucet
2 Year Warranty

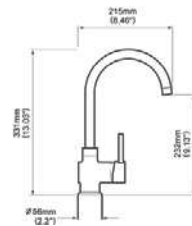

Swan Neck Galley Chrome Faucet
TT1211

Telescopic Range Ideal for Tight Spaces



FT1160
Telescopic Faucet
1 Year Warranty

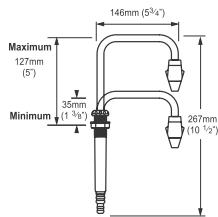

FT1160



FT1276
Tuckaway Faucet
1 Year Warranty

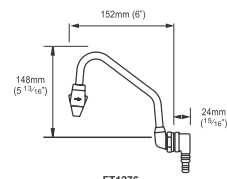

FT1276

FT1152 - Telescopic Faucet

Interior Showers - Chromed Brass

High quality polished chrome finish

Modern Scandinavian style chromed brass faucet interior shower
Pull out ideal for tight spaces

2 Year Warranty

Features and Benefits

Why Whale Chromed Brass Showers?

- High quality chromed brass polished finish
- Easy to use single lever swivel to adjust temperature and flow
- Straightforward plumbing - Supplied complete with 1/2" faucet tail connections and securing kit
- Save space with our pull out mixer
- Scandinavian minimalist designs



Product code: see table

i Product Information

TT8011	Modern Single lever Style- chromed brass internal shower - mixer, hose, handset and riser rail Overall length: 600mm (23 5/8") Distance between mounting holes- 538mm 21 1/4")
TT4180	Modern Single lever Style - chromed brass mixer pull out galley mixer (chrome) 1/2" BSP

Tips To maintain polished chrome finish, simply wash down with clean soapy water only, as abrasive cleaning agents may cause damage

COMPLETE YOUR SYSTEM

Freshwater system accessories such as water filters, and pipework connections – page 76-77

YOU MAY ALSO LIKE

- Whale Twist® - Deck Shower with integrated temperature and flow controls – page 70
- Fresh IC freshwater power shower pump with intelligent control built in- page 46
- Whale chromed brass faucets and showers – page 64-68

Interior Showers - Elegance

FRESH WATER

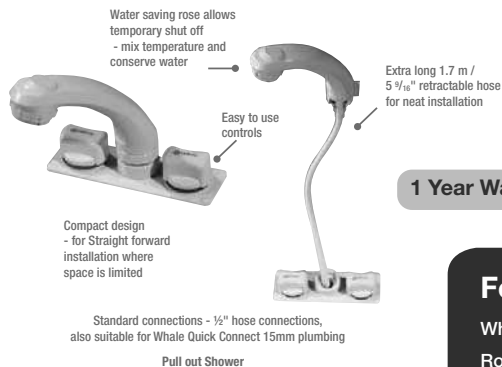

Product code: see table

Lightweight and durable ABS showers
marine grade materials
Ideal for tight spaces

1 Year Warranty

Features and Benefits

Why Elegance Pull Out shower?

Robust ABS construction

Design for use with all types of galley pumps

Connects to Whale Quick Connect 15 mm pipework/
3/8" or 1/2" hose connections

Choice of single or mixer faucets

Over 30 years experience - designed, refined and made in our UK facility since the early 1980s

COMPLETE YOUR SYSTEM

Freshwater system accessories such as water filters, and pipework connections – page 76-77

YOU MAY ALSO LIKE

Whale Twist® - Deck Shower with integrated Temperature and Flow Controls – page 70

Fresh IC freshwater power shower pump with intelligent control built in- page 46

Whale chromed brass Faucets and showers – page 64-68

Accessories

Product Code	Model
RT1770	Shower Riser Bar (for use with RT2498)
RT1270	Shower Wall Bracket (for use with RT2498)
RT9000	Replacement Microswitch Kit

Model Specifications

Model	RT2498
Description	Mixer Combination Faucet / Shower
Colour	White
Hose Connections	1/2" Threaded
Base Plate (mm)	171 x 62 (6 3/4" x 2 1/2")
Depth Beneath Surface	80 mm (3 1/4")
Connection to Quick Connect 15 mm Plumbing	WX1532
Connection to 13 mm (1/2") Flexible Hose	WX1532 WX1584B
Service Kits	AS5133 - Replacement Handset 1/2" BSP Threaded (white) AS5146 - Replacement Hose Assembly 1.7 m (5 7/16 ft) Long (white)

Note: These specifications are retail items only.

For details of our bulk pack range for boat builders and wholesalers - contact Whale Support.

12mm faucets are now replaced by 1/2" connections models see table. AS5123 - handset 12mm, AS5145 12mm connection shower hose available.

Whale Twist® Deck Shower

NEW Whale Twist® Deck Shower with integrated Temperature and Flow Controls

An award winning radical innovation in deck showers. The Twist puts control in your hands with its unique handset incorporating temperature and flow control in a single easy to use unit.

A radical innovation in deck showers putting control in your hands

Unique Whale Twist® Handset

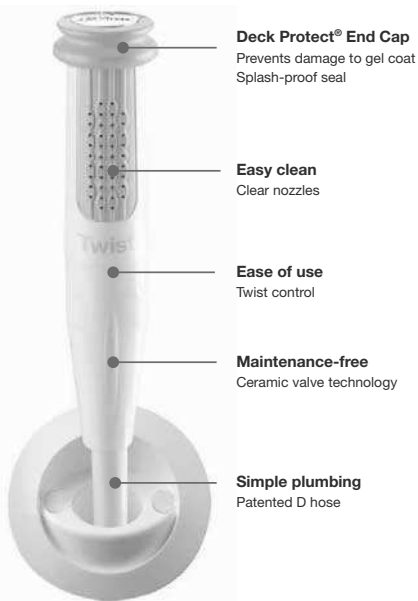

Deck Protect® End Cap
Prevents damage to gel coat
Splash-proof seal

Easy clean
Clear nozzles

Ease of use
Twist control

Maintenance-free
Ceramic valve technology

Simple plumbing
Patented D hose



Long life
Marine-grade materials

Ease of Installation

- Compact unobtrusive housing
- Only one circular hole to cut and simple plumbing connection

Product codes:
DS0005 Cold only
DS0006 Mixer

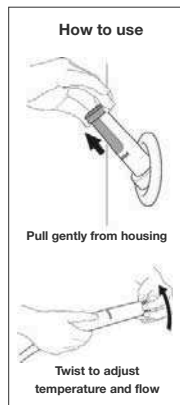

Typical Installation

AWARD WINNING DESIGN
Institute of Designers in Ireland - Product Design Award

Accessories - For deck showers AK0015 Twist storage bag

- for neat stowage of DS0005/ DS0006

Note - this product is only suitable for use with 2.5 metre (8.2 ft) hose Twist® models)



AK0015

Features and Benefits

Unique Integrated Handset

- Incorporates shower temperature and flow controls
- Easy to use-streamlined ergonomic design
- High quality UV resistant ASA materials

No Lids or Covers

- Deck Protect® End Cap creates a splash-proof seal

Mounts in Convenient Locations

- Housing options offer a choice of horizontal or vertical mounting on a flat or curved surface

Ease of installation

- The new Whale Twist® Deck Shower is quick and easy to install. It is available with either a chrome straight housing, or a white angled housing

Plumbing

- All Whale Twist® Deck Shower models are easy to plumb. Mixer models include a temporary shut off valve as standard.

1 Year Warranty

Award Winning Design

- IDI Award - Institute of designers in Ireland - Product design award winner
- DAME Innovation Awards 2007 - Special mention

COMPLETE YOUR SYSTEM

Freshwater system accessories such as water filters, and pipework connections – page 76-77

YOU MAY ALSO LIKE

Fresh IC freshwater power shower pump with intelligent control built in- page 46

NEW Supersub Smart – Narrow low profile Automatic Bilge Pumps – page 12

Whale faucets and showers – pages 62-75

i Product Information

Model Specifications

Model	Whale Twist® DS0005 cold only	Whale Twist® DS0006 mixer hot & cold
Weight	130 g (0.3 lbs) / 200g (0.45 lbs)	
Hose Length	2.5 m (8.2 ft)	
Hose Connections	½" threaded connections	
Materials	Handset - ASA, Internal parts -TPE, Nitrile®, POM, Hose - Reinforced Polyurethane, Hose connections - PBT, End Cap - Chromed ABS, Straight Housing - Chromed ABS, glass-filled Polypropylene, Angled Housing - ASA, Screws and Hose Clips - Stainless Steel	

Whale Twist® Retail packed models (individual carton)

Product Code	Description
DS0005	Whale Twist® Deck Shower Cold only (Pale grey / white) with 2.5 m (8.2ft) white hose. Includes straight housing (chrome) and angled housing (white) options
DS0006	Whale Twist® Deck Shower - Mixer (Pale grey / white) with 2.5 m (8.2ft) white hose. Includes straight housing (chrome) and angled housing (white) options

Note: Retail packed models include plumbing connections for 15 mm Whale Quick Connect or ½" threaded

The Whale Twist® Deck Shower is protected by the following patent and design registration applications:

This product is protected by the following patents and patent applications: Australian Patent Application No. AU 2007 231705; European Patent Application No. EP 07 119 601.8; United States Patent No. US 7 753 291; Norwegian Patent Application No. NO 2007 5455; and New Zealand Patent No. NZ 562931.

Patents pending in Europe (EP 2171164, EP 2179095), the USA (US 20100288852, US 20100294861), and Australia (AU2008261206, AU 2008261207)

Registered Community Design Nos 000805957-0001,0002,0003

United States Design Patents USD 588683 & USD 583012

Canadian Registered Design Nos 124293 & 124294

Australian Registered Design Nos 319453 & 318959

WHALE TWIST® and DECK PROTECT™ are trade marks of Munster Simms Engineering Limited (also trading as Whale Water Systems).

Note: These specifications are retail items only.

For details of our bulk pack range for boat builders and wholesalers - contact Whale Support.

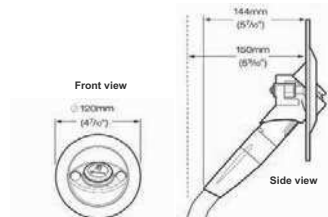

Angled Housing

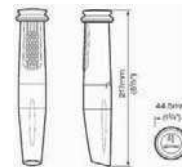

Handset

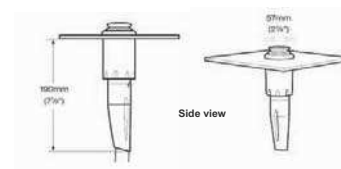

Straight Housing

Swim 'n' Rinse Compact Deck/ Transom Shower Range

Whale Swim 'n' Rinse Compact Shower Stainless steel covers (hot and cold mixer)

Ideal for installation where space is limited on deck and behind the bulkhead -Simply swim and rinse without wasting water.



Product code: see table

- Sleek cover
- for a neat finish on deck
- Long Life UV resistant ABS housing is designed and tested to withstand extreme marine conditions
- Easy use controls even with soapy hands

NEW Whale Swim 'n' Rinse Compact Shower with Rubber cover (cold only)

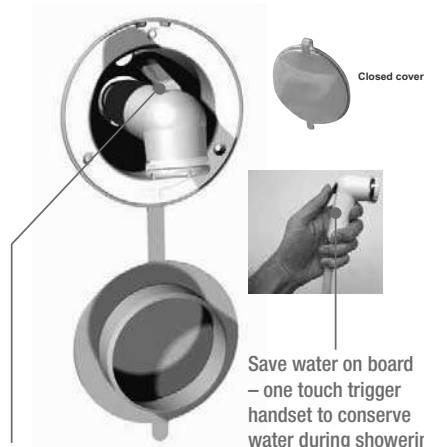

Lightweight handset will not damage the gel coat if dropped on deck

Product code: see table

Features and Benefits

- Press trigger to only use the water you need
- Crisp and clean - chrome and white finish
- Extra long hose allows you to fit in most convenient location on deck
- Highest quality finish - marine grade stainless steel or UV stabilized PVC cover options
- Simple installation - standard size circular holes to drill
- Standard connections - suitable for 3/8" BSP threaded connections/ Whale Quick Connect 15mm plumbing

1 Year Warranty

COMPLETE YOUR SYSTEM

Freshwater system accessories such as water filters, and pipework connections – page 76-77

YOU MAY ALSO LIKE

Whale Twist® - Deck Shower with integrated temperature and flow controls – page 70

Swim 'n' Rinse– deck shower – The classic transom Shower – page 74

Fresh IC freshwater power shower pump with intelligent control built in - page 46

Universal Pressure Pumps – page 48

Whale faucets and showers – page 62-75

Product Information

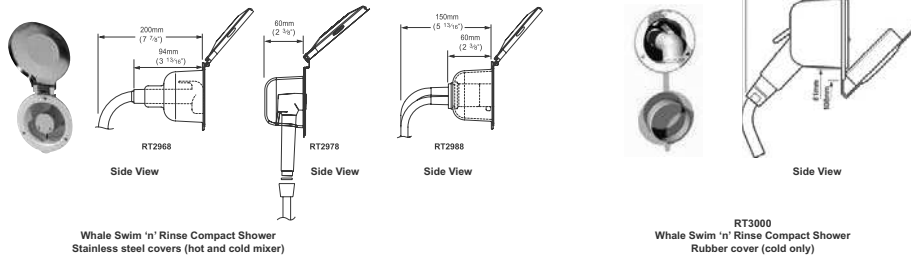

Whale Swim 'n' Rinse Compact Shower
Stainless steel covers (hot and cold mixer)

RT3000
Whale Swim 'n' Rinse Compact Shower
Rubber cover (cold only)

Model Specifications

Product Code	Whale Swim 'n' Rinse Compact Shower Stainless steel covers (hot and cold mixer)			Whale Swim 'n' Rinse Compact Shower Rubber cover (cold only)
	RT2968 Shower Handset	RT2978 Shower Handset	RT2988 Shower Mixer	RT3000
Description	Horizontal mount holder with stainless steel cover	Vertical mount with stainless steel cover		White and Chrome with angled holder and one touch trigger handset
Diameter of mounting hole	80mm (3 1/4")			
Hose length	2.1m (7ft)		n/a	2.6m (8.5ft)
Hose Connections	3/8" BSP Threaded Male Female 1/2" threaded connections 3/8" threaded adaptor			3/8" adaptor x 1/2" female adaptor
Depth Behind the Surface	200mm (7 7/8")	60mm (2 3/8")	150mm (5 7/8")	130 mm (5 1/8")
Weight	0.8kg (1 1/2 lbs)			0.535kg (1.18 lbs)
Materials	Mixer valve and handset: chrome plated brass housing UV stabilized Polypropylene, Cover and fixings Stainless steel			Internal components - Hostaform, stainless steel 304, housing UV stabilized Polypropylene, PVC Cover - UV stabilised PVC, fixings - stainless steel
Colour	chrome and white			
To connect to Whale Quick Connect 15mm Plumbing	WX1583B			

Note: These specifications are retail items only.
For details of our bulk pack range for boat builders and wholesalers - contact Whale Support.
Maximum cold water pressure 2 bar (30 psi)

Swim 'n' Rinse Transom Shower

The classic design in deck showers for easy washdown on the transom after swimming. Simply swim and rinse without wasting water.

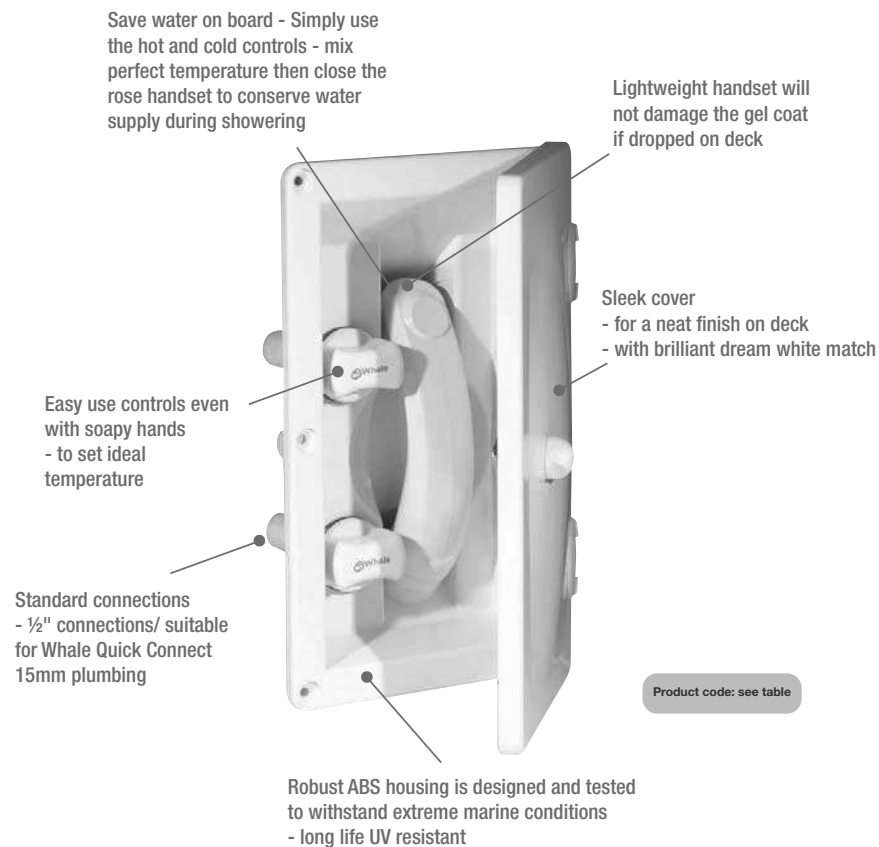

Features and Benefits

Lightweight and durable ABS exterior shower range - add a touch of luxury on board

- Designed for easy rinse down after swimming
- Fit in convenient locations on deck - extra long 2.1 m (7 ft) hose
- Save water on board - On/off control on shower handset allows you to set temperature and only use the water you need
- Neat hinged cover with latch to close
- Blends in on deck - White high shine finish matches the gel coat
- Available with/without cover
- Straight forward installation - simple connection to either Quick connect 15mm pipework/ 1/2" hose connection

1 Year Warranty

COMPLETE YOUR SYSTEM

Freshwater system accessories such as water filters, and pipework connections – page 76-77

YOU MAY ALSO LIKE

Whale Twist® - Deck Shower with integrated Temperature and Flow Controls – page 70

Swim 'n' Rinse Compact – deck shower – Ideal where space is limited on deck – page 72

Fresh IC freshwater power shower pump with intelligent control built in- page 46

Universal Pressure Pumps – page 48

Whale® water filters – page 76

i Product Information

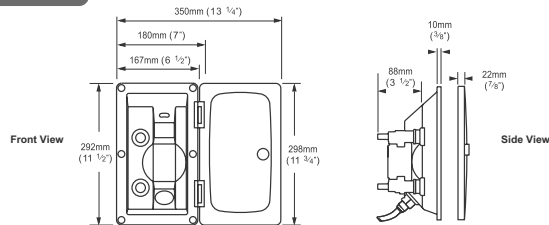

Model Specifications

Model	Cold Only (no cover)	Cold Only (cover included)	Hot and Cold Mixer (no cover)	Hot and Cold Mixer (cover included)	Hot and Cold Mixer (lockable cover included)
Product Code	RT1648	RT1649	RT2648	RT2658	RT2662
Colour	White				
Base Plate	167 mm (6 1/2") X 292 mm (11 1/2")				
Depth Beneath Surface	88 mm (3 1/2")				
Hose Connections	1/2" Male Threaded (BSP / NPT)				
Connection to Quick Connect 15 mm Plumbing	Use WX1532 - Adaptor Female 1/2" - 15 mm				
Hose Length	2.1 m (7 ft)				

Note: These specifications are retail items only.
For details of our bulk pack range for boat builders and wholesalers - contact Whale Support.

Fresh Accessories

Complete Your System

Whale® high quality pumps and accessories to ensure long term reliability from pump to faucet.

Whale® water filters, surge dampers, pressure switches and one way valves are designed and manufactured with highest quality at heart. Combine these accessories with your whale water pump for a home from home water supply on board.

Need specific advice on your freshwater system? Contact our technical team at Whale support
See below for a full list of accessories

Inline Water Filters

Aquasource Clear Water Filter

For refreshing tasting water on board

- silverised carbon filter - removes nasty tastes and smells
- connects directly to 15mm Quick Connect Plumbing/ ½" (13mm) flexible hose (using stainless steel hose clips)
- Note - this is not a bacterial filter

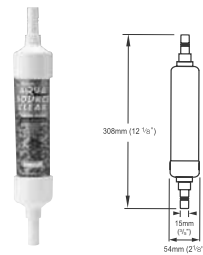

WF1530

Pump Strainer

Inlet Strainer Replacement

Suitable for Fresh IC - page 46, and Universal freshwater pumps- page 48

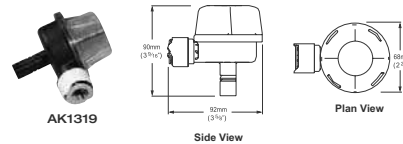

AK1319

Side View

Plan View

Inline Pressure Switch

Inline Pressure Switch

For use with submersible or in line self venting pumps in a pressurized water system

- Controls the pump by sensing changes in system pressure.
- Current rating = 10amp: 12 V d.c. systems / 5 amp : 24 V d.c. systems
- Maximum Pressure: 2 bar (30 psi)
- Materials: body: acetal, seals and valves: Nitrile®, EPDM
- spring: phosphor bronze, fasteners: stainless steel
- Note: must be mounted in a vertical position

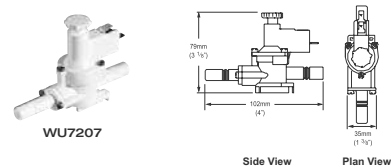

WU7207

Side View

Plan View

Expansion Vessels

Surge Damper

For a smooth constant water supply

- Capacity = 150ml (1/4 pint)
- Max. pressure 4 bar (60 psi)
- connects directly to 15mm Quick Connect Plumbing/ 1/2" 13mm flexible hose (using stainless steel hose clips)
- note - connect as close to the outlet of the pump as possible or as close to the outlet side of the pressure switch (if fitted)



WS7215

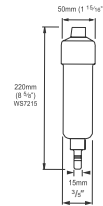

FRESHWATER

Pipework Connections

One Way Check Valves for 13mm (1/2") flexible hose (white)

fit in line to maintain prime for short periods

- Ideal for use with electric pumps
- Suitable for connection to 13mm 1/2" flexible hose
- Ensure the valve is installed with the arrow pointing in direction of water flow
- Note - low restriction design will have a small drip return



FV1227

FV1235

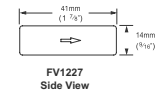

FV1227

Side View

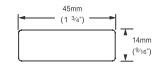

FV1235

Side View

Hose Fitting Y-piece 13mm (1/2") - acetal

Ideal to simplify pipework connections from 2 pumps



YP6130

Accessories for Taps and Showers

Microswitch Kit

(for Elegance range and Swim 'n' Rinse page 62-63, 68 and 75)



RT9000

AK0015 Accessories - For deck showers

Twist storage bag

- for neat stowage of DS0005/ DS0006 - page 70

Note - this product is only suitable for use with 2.5 metre (8.2 ft) hose Whale Twist® models



AK0015



Whale - Wash Down Range



Our washdown pumps have been refined, tested and proven for decades. Easy to use products that deliver great performance to washdown your deck.

Washdown

- Saltwater Washdown Kit - High capacity washdown pumps and trigger handset kits - Page 80-81

Portable Washdown and Boat Cleaning

- Portable Pump Kit - The versatile solution for deck washdown or boat cleaning - Page 82

Accessories

- See Freshwater accessories to complete the system - Page 76-77

Note - for washdown faucets see page 64-67

Washdown

Saltwater Washdown Kit

Saltwater Washdown pump and trigger kit

Pump and trigger handset in one easy fit kit delivers high pressure targeted flow

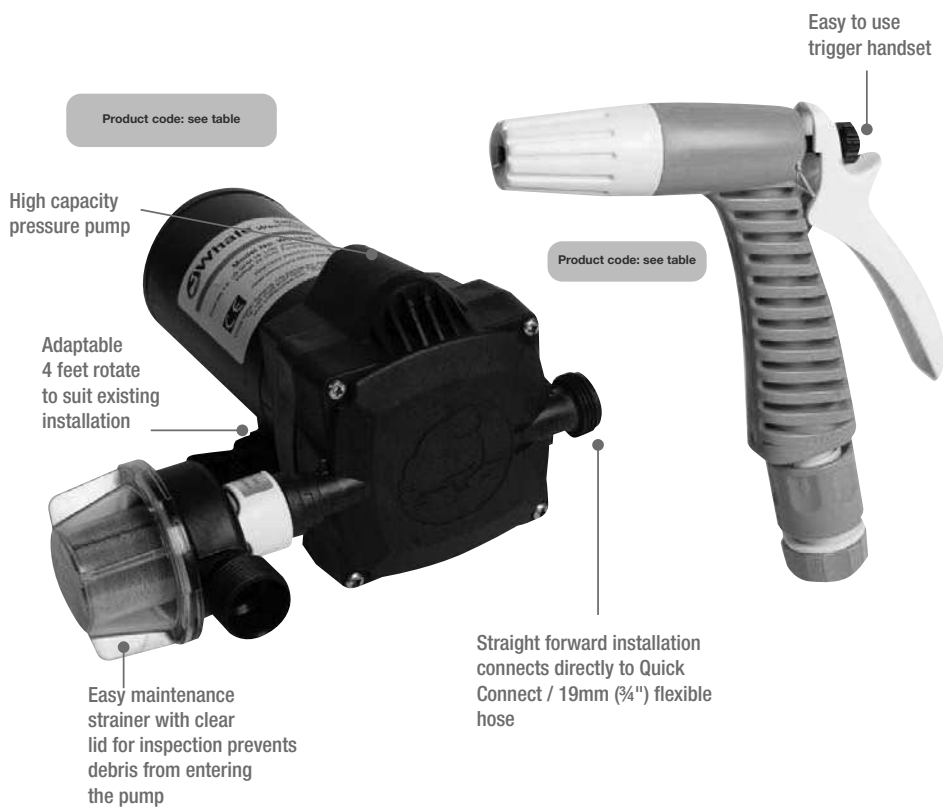

Features and Benefits

TRIGGER

- Trigger handset with adjustable jet and lockable lever
- Lock/unlock lever to conserve water
- Comfortable trigger design
- Simple push in hose fitting with dry decoupling valve

PUMP (also available separately)

- High pressure pump - smooth constant flow
- Self-priming up to 3 m (10 ft)
- Internal pressure switch - Extra protection and safety with wires
- Pumps universal mounting arrangement fits any existing installation
- Suitable for use with saltwater and freshwater
- Reliability - Runs dry without damage

2 Year Warranty

Awards and Accreditations

- IP65 rated
- CE marked
- ISO 8846

COMPLETE YOUR SYSTEM

See page 76-77 for freshwater system accessories

YOU MAY ALSO LIKE

- Twist Deck Shower with integrated temperature and flow controls – page 70
- Swim in rinse deck shower with flow control at the handset to conserve water – page 74
- Washdown spigot –faucet page 64
- Portable pump kit – page 82

i Product Information

Performance Data

Model	Washdown pump and trigger kit (12 V d.c.)	Washdown pump and trigger kit (24V d.c.)	Washdown Pump 18 ltr (4.8 US gals) (12V d.c.)	Washdown Pump 18 ltr (4.8 US gals) (24 V d.c.)
Product Code	WD1815	WD1825	UF1815	UF1825
Flow Rate / min	18 ltrs (4.8 US gals)			
Voltage	12 V d.c.	24 V d.c.	12 V d.c.	24 V d.c.
Recommended Fuse Size (automotive)	12 Amp	8 Amp	12 Amp	8 Amp
Weight	3.2kg (7 lbs)		2.9kg (6.4 lbs)	
Inlet/ outlet size	3/4" 19mm male thread			
Handset connections	Click fit trigger- snap in joint with flow lock/ dry link coupling		n/a	
Cut out pressure	3 bar (45 psi)			
Semirigid pipework system connections	For Quick Connect 15mm Use WX1542 (available separately)			
Additional fittings	3/4" Flexible Hose adaptors qty 2 and 1/2" adaptors qty 2 (included)			
Materials	Pump Body: Glass-filled Polypropylene, Motor Casing: Aluminium, Power-coated Steel Diaphragm, Valves, Feet: Monprene®, Seals: Nitrile®, Fasteners: Stainless Steel			
Materials in contact with fluid	Glass filled polypropylene, Monprene®, Santoprene®, Nitrile®, stainless steel			
Service Kits	Replacement head service kit AK1316 (available separately) Strainer replacement AK1329 Microswitch AK1317			
Maximum Wire Size	2.5mm ² (13 AWG)			
Maximum Discharge head	30 m (98ft)			
Maximum lift	3m (10ft)			

Note: These specifications are retail items only.

For details of our bulk pack range for boat builders and wholesalers - contact Whale Support.

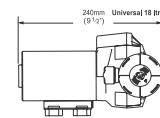
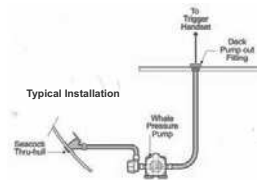

Side View

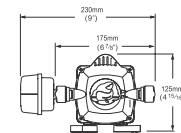

Front View

Washdown

Portable Pump Kit

Self-Venting Portable Pump Kit

The Versatile Portable Pumping Solution!

Features and Benefits

- Wash down your boat
- Great performance and low voltage pump
- Easy to maintain with a wipe clean hose and nozzle
- Suitable for cold and warm water, diesel, light oils and water-based fluids including most water-based pesticides

The kit now includes

- Low voltage high flow submersible pump
- Nozzle with adjustable on / off, fine spray or a jet of water
- 3.75m (12.5 ft) food quality clear hose
- 3.75m (12.5 ft) cable with battery clips and cigar lighter connector

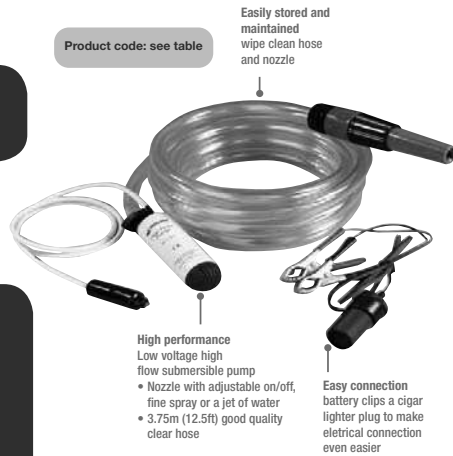

1 Year Warranty

Awards and Accreditations

- CE marked

COMPLETE YOUR SYSTEM

See page 76-77 for freshwater system accessories

YOU MAY ALSO LIKE

Twist Deck Shower with integrated temperature and flow controls – page 70

Swim 'n' Rinse deck shower with flow control at the handset to conserve water – page 74

Washdown spigot – faucet page 64

Saltwater Washdown Pump and trigger kit – page 80

Product Information

Model Specifications

Model	Self Venting Portable Submersible Pump Kit
Product Code	GP1642
Voltage	12V d.c.
Rec. Fuse Size	5 Amp automotive
Power Connection	Crocodile Clips and Cigar Lighter Plug
Weight	0.70 kg
Materials	Stainless Steel, Nitrile [®] , PVC, Polypropylene, ABS Plastics

Performance Data

Head	Flow Rate and Current Draw
0m (0ft)	15.8 ltrs / min (3.8amps)
1m (3ft)	12.8 ltrs / min (3.5 amps)

Note: These specifications are retail items only.
For details of our bulk pack range for boat builders and wholesalers - contact Whale Support.

WARNING
Note: Not suitable for petrol, low flash point liquids and aggressive chemicals.
This pump must not be used for pumping petrol or any highly inflammable or corrosive liquids.

Watertight Locker Doors / Deck Hatches

LOCKER DOORS



LD4002

1 Year Warranty

Watertight seals
Easy inspection
- Models with clear hatch available
Durable
- manufactured from robust materials

Product code: see table



LD2000



LD3000



LD4000

Keep storage areas dry with our watertight robust designs – tried, tested and trusted for decades

Features and Benefits

Provide Easy Access To Storage Space

Aluminium Models - Suitable For Sandy Environments

TCL2

- Robust aluminium construction with locking lever ideal for harsh marine environments

TCL3

- Robust aluminium ring with durable plastic cover
- Ideal for narrow bulkheads
- Quick release camlock cover allows easy access to storage areas

Polycarbonate Models

TCL 4

- Reliable watertight seal
- TCL 4 Clear - allows easy inspection without having to open the locker

YOU MAY ALSO LIKE

Twist Deck Shower with integrated temperature and flow controls – Page 70

Fresh IC freshwater power shower pump with intelligent control built in - page 46

Supersub Smart – the automatic narrow low profile electric bilge range – page 12

i Product Information

Model Specifications

Model	TCL2	TCL3	TCL4	TCL4 Clear
Product Code	LD2000	LD3000	LD4000	LD4002
Diameter	236 mm (9 1/4")	Not Applicable	236 mm (9 1/4")	236 mm (9 1/4")
Aperture	179 mm (7")	143 mm x 82.5 mm (5 5/8" x 3 1/4")	179 mm (7")	179 mm (7")
Materials	Body: Diecast Aluminium Alloy Seal: Nitrile®		Body: Polycarbonate Locking Ring: Acetal Seal: Nitrile®	

Note: These specifications are retail items only.
For details of our bulk pack range for boat builders and wholesalers - contact Whale Support.

What the customers say

"Your deck hatches did the job perfectly, our deck storage areas stayed perfectly dry..."

Cath Allaway – Extreme Rowing Expenditure

Quick Connect Pipework and Fittings

Plumbing Systems

Quick Connect Plumbing System

Whale Quick Connect fittings ensure a high integrity, reliable, plumbing system solution, specifically designed for use in mobile applications.

Save Time and Money by Using Whale Quick Connect

Fittings and pipework design ensures easy installation and re-usability of components. The simple two step installation procedure does not require special tools to make a watertight connection.

Features and Benefits

- Unique 'Double Gripper' design provides secure lifelong pipework retention even at excessive pressures
- The innovative 'cage collet' eliminates leaks where fittings are installed close to tight bends
- Collet has internal support ring ensuring o ring seal is held in position and does not distort or leak under pressure
- High integrity single piece moulding improves the strength of the fittings
- Outer sleeve incorporates collet cover, thus preventing accidental pipework release
- Collet clips are not necessary and therefore reduce installation time
- Pipework includes measured cut marks, designed to be a visual guide to ensure that fittings are pushed fully home

Whale Quick Connect Semi-Rigid Pipework

Whale Quick Connect colour coded semi-rigid pipework is available in 12 mm, 15 mm, and 22 mm sizes in standard or high performance (Whalex) PE materials. The pipework's flexibility enables tight bends to be formed, hence reducing both the number of fittings and time required at installation. Whale Quick Connect semi-rigid pipework offers the integrity of metal, but the usability of plastic, and is fully tested and recommended for use with the complete range of Whale fittings (see pages 86 and 87).





Minimum Bend Radii Recommendations

All grades of Whale Quick Connect semi-rigid pipework are flexible and can be bent into a tight radius to facilitate easy installations. This reduces the number of fittings required and the cost of the total water system.

Whale Tubing	Minimum Bend Radius
15mm	75mm

This product is protected by the following granted patents:
United States Patent No. US 6,349,978; German Patent No. 69810350.5 (EP(DE) 1 032 785); French Patent No. FR 1 032 785; United Kingdom Patent No. GB 2 331 564; and Dutch Patent No. NL 1 032 785.

Installation Guide

<p>Step 1 Cut pipework to length by making a straight clean cut using Whale cutters WX7950 (WX7951-USA only) (see fig. 1)</p>		
<p>Step 2 Simply push the pipework length into the fitting to the second internal stop (see fig. 2)</p>		
<p>Step 3 To release pipework: Push back the grey collet into the fitting, then hold the collet in and pull out the pipework length (see fig. 3 and 4)</p>		

The Whale Quick Connect products are protected by the following patents
UK Patent Number: 2331564, European Patent Number: 1032785
USA Patent Number: 6349978

Materials		
Whale Quick Connect Fittings	Glass-filled Polypropylene	
Whale Quick Connect Pipework	Polyethylene	

Recommended Maximum Operating Conditions	Maximum Pressure	Maximum Temperature
	Hot Water	6 bar (90 psi)
Cold Water	12 bar (180 psi)	20°C (68 °F)

Minimum Bend Radius	
Quick Connect 15 mm Pipework	75 mm

Minimum Storage Temperature

The minimum dry storage temperature is -40 °C (-40 °F)

Note: It is vital that the system is fully winterized to prevent frost damage.



WARNING: Temperature Settings – To prevent scalding, (regardless of the water heating method or the control devices used), the temperature for the hot water supplied to the faucets and showers should be controlled in the range of 43 °C to 60 °C (110 °F to 140 °F) with a fail safe set at 82 °C (180 °F).

CAUTION: Ideally, the temperature should be set at 46 °C (115 °F) for health and safety reasons, higher settings will increase the risk of scald injury. Those at greatest risk of scald injury include children, the elderly, disabled, and diabetics.

Fail Safe Controls



WARNING: In a typical marine installation, it is vital to incorporate primary and fail safe controls for water temperature and pressure. Please see list below:

PRIMARY CONTROLS:

Thermostatic Mixer Valve: WX1599B

Pressure Switch: WU7207(B) - In-Line Pressure Switch or included in the Universal Pressure Pump (see page 76)

Pressure Regulator: WX1595B - Pressure Relief Valve - 6 bar 1/2" Female

Expansion Vessel: Accumulator Tank

FAIL SAFE CONTROLS:

WX1595B - Pressure / Temperature Relief Valve

(For typical installation of these necessary controls see page 49)

(For a full list of our part numbers see pages 86-87)

(For advice on specific installation requirements contact Whale - see contact details)

Note: The patented Whale Plumbing System is specifically designed to be use in "mobile" applications. Whale Quick Connect fittings and Whalex pipework (any) are covered for 10 years from date of purchase (except WX1599). For use with Whale plastic tubing and grooved stems only.

Quick Connect Pipework and Fittings

15 mm



Threaded 3/4"



Threaded 3/8"



Part Numbers Explanation:

B Suffix: refers to items available only in bulk packed quantities for high volume production OEM use

(B) Suffix: refers to items available in either retail packaging (e.g. WX1502) or in bulk packed quantities for high volume production OEM use (e.g. WX1502B).

Threaded 1/2"



Quick Connect Pipework and Fittings

Flexible Hose Fittings 1/2"



WX1544(B)
1/2" Hose Connector (Brass)



WX1584(B)
Stem Adaptor 1/2"
Flexible Hose Male



WX1585B
Tee 1/2" barb X 1/2" barb X 1/2" barb



WX1586B
Tee 1/2" barb X 15 mm WX X 1/2" barb



WX1591(B)
Stem Elbow 1/2" Flexible Hose

Flexible Hose Fittings 3/4"



WX1555B
Tee 3/4" barb X 3/4" barb X 3/4" barb



WX1556B
Tee 3/4" barb X 15 mm WX
X 3/4" BARB



WX1557B
Tee 3/4" barb X 1/2" barb X 3/4" barb



WX1558B
Tee 1/2" barb X 1/2" barb X 3/4" barb



WX1592(B)
Stem Elbow 3/4" Flexible Hose



WX1593(B)
Stem Adaptor 3/4" Flexible Hose



WX2259B
Adaptor 22 Spigot X 3/4" barb

Other Connections



WX1517B
3/16" X 24 UNEF Male Faucet Tail
Adaptor (Brass) suitable for Gröbe
Faucets



WX1535B
Stem Adaptor 1/8" Hose (Brass)
for Windscreen Washer



WX1537B
Stem Adaptor 1/4"
NPT Female (Brass)



WX1566B
Tank Fitting Assembly



WX2260B
End Stop 22mm Spigot



WX1528(B)
Adaptor 3/8" - 15mm

Plumbing Safety Fittings



WX1595B
Pressure Relief Valve - 6 bar
1/2" Female



WX1599B
Thermostatic Mixer Valve 1/2" Male
(Brass) 15 mm and Check Valve /
Non-Return Valve
Note: This product is covered by 1
year warranty

Flexible Hose Fittings Other



WX1548B
3/8" Hose Connector (Brass)



WX1597(B)
Stem Adaptor 3/8" Flexible Hose

Colour Coded Tubing



WX7152
Standard Semi-Rigid Pipework
15 mm Blue 10 m (33 ft)



WX7152B
Standard Semi-Rigid Pipework
15 mm Blue 50 m (164 ft)



WX7154
Standard Semi-Rigid Pipework
15 mm Red 10 m (33 ft)



WX7154B
Standard Semi-Rigid Pipework
15 mm Red 50M (164 ft)



WX7156
Standard Semi-Rigid Pipework
15 mm Green 10 m (33 ft)



WX7156B
Standard Semi-Rigid
Pipework 15 mm Green 50 m (164 ft)



WX7162B
WHALEX Semi-Rigid Pipework 15 mm
High Performance Blue 50 m (164 ft)



WX7562B
WHALEX Semi-Rigid Pipework 15 mm
High Performance Blue 152 m (500 ft)



WX7164B
WHALEX Semi-Rigid Pipework 15 mm
High Performance Red 50 m (164 ft)



WX7564B
WHALEX Semi-Rigid Pipework 15 mm
High Performance Red 152 m (500 ft)



WX7166B
WHALEX Semi-Rigid Pipework 15 mm
High Performance Green 50 m (164 ft)



WX7168B
WHALEX Semi-Rigid Pipework 15 mm
High Performance White 50 m (164 ft)

Tools



WX7950
Pipework Cutters - must be used to cut
Whale Semi-Rigid Pipework



WX1569B
Pipework Mounting Clip (White)



WX1565(B)
Pipework Mounting Clip (Black)

WHALEX Pipework is NSF61 listed and has the benefits of a more scratch-resistant surface and greater durability.

PIPEWORK



Whale - Grey / Shower Waste

Electric Grey Waste Pumps and Tank Systems



Whale's Gulper Pumps for shower/ grey waste have led the way for more than a decade in durability and non-clog valve technology - truly a fit and forget solution for shower waste. Our full range includes pumps and tanks and pre-assembled kits for managing shower waste on board.

Electric Grey Waste Pumps

Whale Gulper non clog electric grey waste pumps are proven to be reliable and able to handle typical shower waste such as hair and shower gel. No filters to clog
- proven performance for the long haul.

Multi-port Polyethylene Tanks

These roto-moulded tanks are hard wearing, and durable, can handle grey waste from multiple drains, but are also compact enough to fit in confined spaces. They are designed for easy installation with our Gulper waste pumps to ensure a robust solution to managing sink, shower, dishwasher waste.

Grey Waste

Electric Grey Waste Pumps

- **NEW** Grey IC - Page 90-91
- **NEW** Gulley IC - Page 92-93
- Gulper 320 - Page 94-95
- Gulper 220 - Page 96-97

Grey Waste Tank Range

- Grey Waste tanks 8ltr and 16 ltr - Page 98-99

Grey Waste Systems

Pre-assembled tank and pump kits

- **NEW** Grey waste tank and pump systems -100 ltr with Gulper - Page 100
- Grey waste tank and pump systems 8ltr with Gulper - Page 101

Accessories

Complete the system with pipework elbows, y pieces, and or non return valves Page - 102-103

Grey IC



Automatic Grey Waste System - manages waste from multiple drains

Whale Grey IC shower waste systems have intelligent control electronics built in ensuring that the pump operates only when required. Includes Gulper[®] IC and 1" (25mm) Two Way Manifold IC with 4m (12ft) of cable

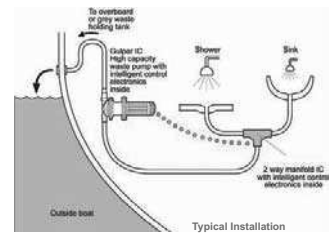

Unique Intelligent Control means that Gulley IC Kit is all you need to manage waste from multiple drains through one pump

Electrical signals are sent from the Two Way Manifold IC only when grey waste water needs to be pumped out.



Features and Benefits

Why Grey IC?

- One pump automatically handles waste from your shower on board - no manual switches required
- Ideal for installation where you don't have space for a grey waste tank
- Easy installation - pre wired plug and play kit
- Reliability - No moving parts to clog

Gulper IC - Automatic control

- One pump handles waste from multiple drains
- Fast drainage - high capacity up to 19 ltrs (5 US gals) /min
- Long life - Self primes and can run dry
- Soft start - protects the pump
- Easy to install - including uneven surfaces
- Optimal drainage - Built in time delay
- Low current controlled switching
- no switch failure from high currents

Two Way Manifold IC

- Fully automatic handles waste from multiple drains as required.
- Senses waste level through wall - not in contact with water
- Removes the need to install a bulky grey waste tank
- Service free - No moving parts to clog or burn

1 Year Warranty

Tips

It is important to ensure that a vented anti-siphon loop is incorporated in the system

Awards and Accreditations

- IBEX Innovation Award 2010 – Special Mention.
- DAME Innovation Award 2010 – Special Mention.



Awards and Accreditations

- Ignition protection ISO8846
- CE marked
- IP45 rated

COMPLETE YOUR SYSTEM

See Page 102-103 for Grey waste accessories

YOU MAY ALSO LIKE

Gulley IC- Automatic Grey waste pump kits with Gulley IC - automatic intelligent control built in – page 92

Bilge IC – Pre-wired Easy Access Remote Mounted Bilge System (4 in 1) with automatic intelligent control built in - page 16

Supersub Smart – Automatic Narrow Low Profile Bilge pump with intelligent control built in – page 12

Product Information

Model Specifications

Model	Grey IC	
Product Code	WM8284	WM8484
Voltage	12 V d.c.	24 V d.c.
Voltage Range	10 to 13.6 V d.c.	21.6 V d.c. to 27.2 V d.c.
Current profile	Soft stop/ start	
Recommended fuse Size (Automotive)	10 Amp	5 Amp
Minimum Wire Size	1.5mm (16 AWG)	
Weight	1.6 kg (3.5 lbs)	
Maximum Suction Lift	3m (10ft)	
Maximum Discharge Head	3 m (10 ft)	
Maximum Discharge head and Suction life combined	4m (12 ft)	
Hose connections	barbed connections 3/4" (19mm) and 1" (25mm)	
Materials	Pump head- Glass-filled Nylon, Valves, and Diaphragm - Santoprene®, clamp ring Acetal, Feet - EPDM, Gear wheel- Delrin®, fasteners Stainless Steel	
Materials in contact with fluid	Glass-filled Nylon, Santoprene®, Stainless Steel	
Service Kit (available Separately)	AK2050- Replacement Pump Head IC	
Accessories	none required	

Performance Data

	0m (0ft)	0m (0ft)	1m (3ft)	1m (3ft)
19 ltrs (5 US gals)				
Discharge Head	1m (3ft)	1m (3ft)	1m (3ft)	1m (3ft)
Hose size	3/4" (19mm)	1" (25mm)	3/4" (19mm)	1" (25mm)
Flow Rate/ Minute	19 ltrs (5 US gals)	17.5 ltrs (4.6 US gals)	17.4 ltrs (4.5 US gals)	15.5 ltrs (4.1 US gals)
Current Draw (12 V d.c.)	7.5 amps	8 amps	7.5 amps	8 amps
Current Draw (24 V d.c.)	3.25 amps	4 amps	3.25 amps	4 amps

Note: These specifications are retail items only.
For details of our bulk pack range for boat builders and wholesalers - contact Whale Support.

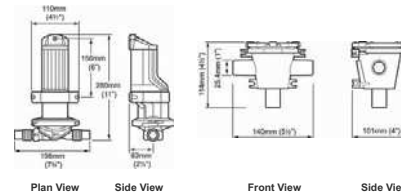

Performance Data

Manifold IC	
Cable Length	4m (12ft)
Hose Connections	1" (25mm)
Control Voltage	5V d.c. via Gulper® IC
Current Draw	Low power 0.01 amps supply
Connectors	IP68 Waterproof Quick Connect 7 way (directly onto Gulper® IC)

Gulley IC



NEW Gulley IC high capacity automatic Grey Waste System - high capacity pump manages waste from a single drain

Whole Grey IC shower waste systems have intelligent control electronics built in ensuring that the pump operates only when required. Specifically designed for shower waste- Includes Gulper IC® electric waste pump and Compact Gulley IC with 4m (12ft) cable for easy installation.

Unique Intelligent Control means Gulley IC Kit is all you need for shower waste management

Electrical signals are sent from Gulley IC only when grey waste water needs to be pumped out. Fully automatic shower gulley drains waste away.

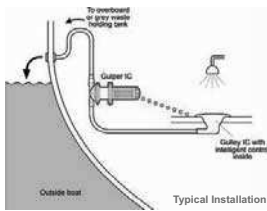

Compact Gulley design senses waste level and controls pump

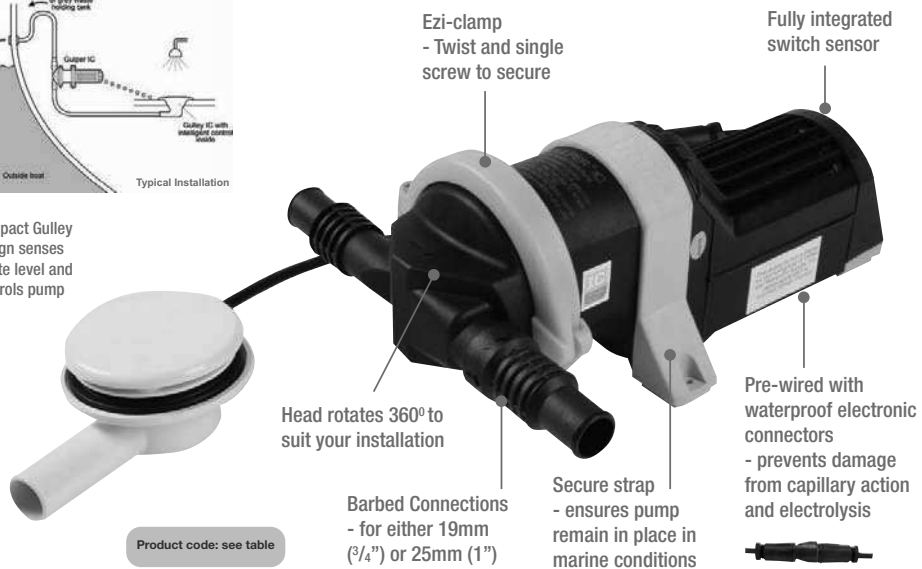

Product code: see table

Features and Benefits

WHY Gulper IC?

- Automatic control - Gulper IC senses the grey waste level and sends signals to Gulper IC to turn off and on as required.
- One pump automatically handles waste from your shower on board - no manual switches required
- Ideal for installation where you don't have space for a grey waste tank

Gulper IC – Electric Non clog Electric Grey Waste Pump with intelligent control built in

- Easy installation - pre wired plug and play kit
- Reliability - No moving parts to clog
- Long life- Self primes and can run dry
- Soft start - protects the pump
- Protected against water ingress - fully potted circuitry
- Low current controlled switching - no switch failure from high currents
- Fast drainage - high capacity up to 19 ltrs (5 US gals) /min
- Optimal drainage - Built in time delay

Gulley IC

- Compact single shower gulley with integrated intelligent control
- Easy clean cover and sleek design
- Protected against water ingress - fully potted circuitry
- Quiet drainage

1 Year Warranty

Tips

It is important to ensure that a vented anti-siphon loop is incorporated in the system

Awards and Accreditations

- IBEX Innovation Award 2010
- DAME Innovation Award 2010 – Special Mention

Awards and Accreditations

- Ignition protection ISO8846.
- CE marked.



COMPLETE YOUR SYSTEM

See Page 102-103 for Grey waste accessories

YOU MAY ALSO LIKE

Grey IC - Automatic Grey waste pump kits with Manifold IC – for automatically managing waste from 2 waste outlets – page 90

Bilge IC – Pre-wired Easy Access Remote Mounted Bilge System (4 in 1) with automatic intelligent control built in - page 16

Supersub Smart – Automatic Narrow Low Profile Bilge pump with intelligent control built in – page 12

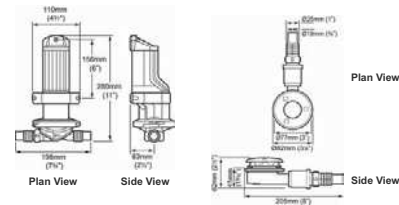

Performance Data

Gulley IC

Cable Length	4m (12ft)
Hose Connections	Small Gulley IC
Control Voltage	5V dc via Gulper® IC
Current Draw	Low power 0.01 amps supply
Connectors	IP68 Waterproof Quick Connect 7 way (directly onto Gulper® IC)

Product Information

Model Specifications

Model	Gulper IC	
Product Code	SG8284	SG8484
Voltage	12 V d.c.	24 V d.c.
Voltage Range	10 to 13.6 V d.c.	21.6 V d.c. to 27.2 V d.c.
Current profile	Soft stop/ start	
Recommended fuse Size (Automotive)	10 Amp	5 Amp
Minimum Wire Size	1.5mm (16 AWG)	
Weight	1.6 kg (3.5 lbs)	
Maximum Suction Lift	3m (10ft)	
Maximum Discharge Head	3 m (10 ft)	
Maximum Discharge head and Suction life combined	4m (12 ft)	
Hose connections	barbed connections 3/4" (19mm) and 1" (25mm)	
Materials	Pump head- Glass-filled Nylon, Valves, and Diaphragm - Santoprene®, clamp ring Acetal, Feet - EPDM, Gear wheel- Delrin®, fasteners Stainless Steel	
Materials in contact with fluid	Glass-filled Nylon, Santoprene®, Stainless Steel	
Service Kit (available Separately)	AK2050- Replacement Pump Head IC	
Accessories	none required	

Performance Data

	0m (0ft)	0m (0ft)	1m (3ft)	1m (3ft)
19 ltrs (5 US gals)				
Discharge Head	1m (3ft)	1m (3ft)	1m (3ft)	1m (3ft)
Hose size	3/4" (19mm)	1" (25mm)	3/4" (19mm)	1" (25mm)
Flow Rate/ Minute	19 ltrs (5 US gals)	17.5 ltrs (4.6 US gals)	17.4 ltrs (4.5 US gals)	15.5 ltrs (4.1 US gals)
Current Draw (12 V d.c.)	7.5 amps	8 amps	7.5 amps	8 amps
Current Draw (24 V d.c.)	3.25 amps	4 amps	3.25 amps	4 amps

Note: These specifications are retail items only. For details of our bulk pack range for boat builders and wholesalers - contact Whale Support.

Gulper[®] 320

High Capacity Waste Pump - Fast Drainage and space saving on board

No clog, no filter waste pump
built on more than a decade of
market leading pump
technology

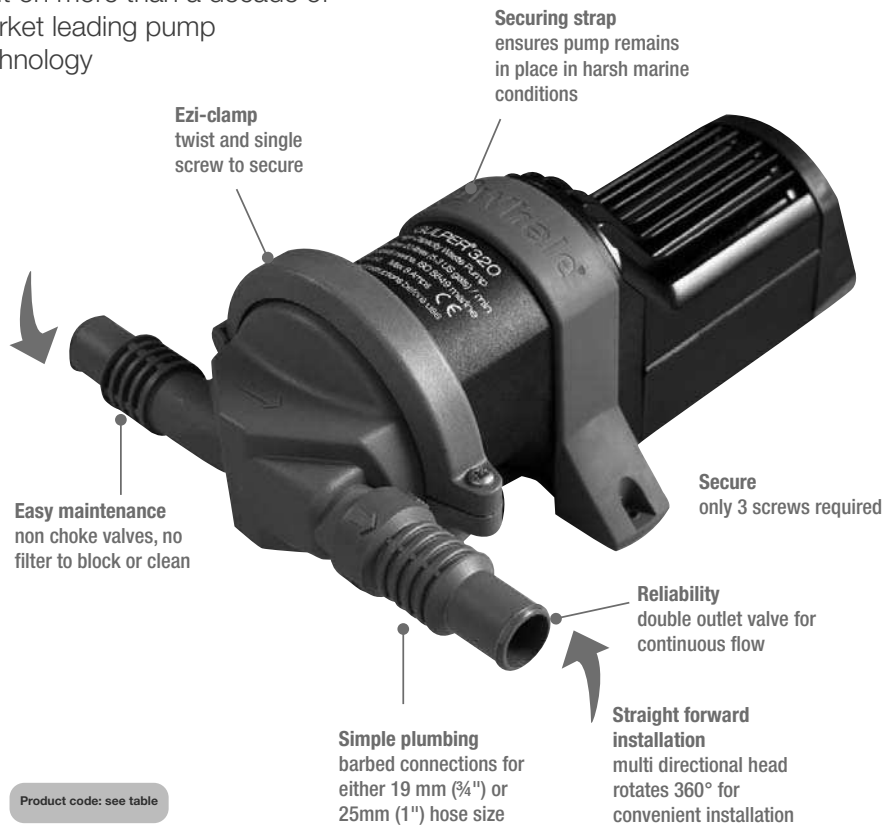

Features and Benefits

Gulper valve technology handles shower waste from multiple drains - no filters and no clogging

High Capacity Waste Pump - Fast Drainage

- Save space one pump multiple drains
- Use smaller grey waste tank
- Head rotates 360 degrees to suit your installation
- Long life - runs dry without damage
- Easy to install - including uneven surfaces
- Reliable operation - Self priming

3 Year Warranty

Awards and Accreditations

- Ignition protection ISO8846.
- CE marked.

COMPLETE YOUR SYSTEM

See Page 102-103 for Grey waste accessories

YOU MAY ALSO LIKE

Grey IC and Gulley IC – Automatic Grey waste pump kits with automatic intelligent control built in – see pages 90 and 92

GREY WASTE

i Product Information

Model Specifications

Model	Gulper® 820	
Product Code	BP2052	BP2054
Voltage	12 V d.c.	24 V d.c.
Hose Connections	3/4" (19mm) + 1" (25mm)	
Recommended Fuse Size	10 Amp Automotive	5 Amp Automotive
Minimum Wire Size	1.5 mm ² (16 AWG)	
Weight	1.6 kg (3.5 lbs)	
Materials	Pump Head: Glass-filled Nylon, Valves and Diaphragm: Santoprene®	
Accessories	Service Kit: AK2050 - replacement pump head	
Maximum Suction Lift	3m (10ft)	
Maximum Discharge Head	3m (10ft)	
Maximum Discharge Head and Suction Lift Combined	4m (13.5ft)	

Performance Data

Model	BP2052 / BP2054			
Suction Lift	0m (0ft)	0m (0ft)	1m (3ft)	1m (3ft)
Discharge Head	1m (3ft)	1m (3ft)	1m (3ft)	1m (3ft)
Hose Size	3/4" (19mm)	1" (25mm)	3/4" (19mm)	1" (25mm)
Flow Rate per Minute	19 ltrs (5 US Gals)	17.5 ltrs (4.6 US Gals)	17.4 ltrs (4.5 US Gals)	15.5 ltrs (4.1 US Gals)
Current Draw	7.5 amps (12 V.d.c.) 3.25 amps (24 V.d.c.)	8 amps (12 V.d.c.) 4 amps (24 V.d.c.)	7.5 amps (12 V.d.c.) 3.25 amps (24 V.d.c.)	8 amps (12 V.d.c.) 4 amps (24 V.d.c.)

Note: These specifications are retail items only.

For details of our bulk pack range for boat builders and wholesalers - contact Whale Support.

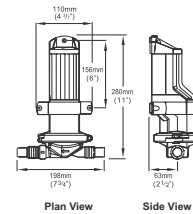
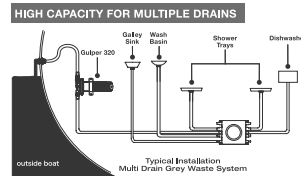

Gulper® 220

Gulper valve technology handles shower waste such as hair and gel
No clog, no filter waste pump built on more than a decade of market leading pump technology



Product code: see table

Also available Gulper 320 High Capacity Model for multiple drains See page 94



Features and Benefits

- Gulper 220 - pumps shower waste including hair and gels
- Up to 14 ltrs (3.7 US gals) per minute*
- Will run dry without damage and pump a mixture of air and water
- Virtually non-choke valves - No filter to unblock
- Reliable operation - Self-priming up to 3 m (10 ft)
- Easy to install in confined spaces
- Double outlet valve ensuring continuous flow
- Multi directional head - for ease of installation
- Low power consumption

2 Year Warranty

Awards and Accreditations

- ISO10133 Electrical systems – extra low voltage dc installations
- Ignition protected ISO8846.
- CE marked
- IP45 rated

COMPLETE YOUR SYSTEM

See Page 102-103 for Grey waste accessories

YOU MAY ALSO LIKE

Grey IC and Gulley IC – Automatic Grey waste pump kits with automatic intelligent control built in – see pages 90 and 92
 Gulper 320 - High Capacity Electric Grey Waste pump – page 94

i Product Information

Model Specifications

Model	Gulper® 220	
	BP1552	BP1554
Product Code	BP1552	BP1554
Voltage	12 V d.c.	24 V d.c.
Recommended Fuse Size	5 amp Automotive	2.5 amp Automotive
Weight	1.5 kg (3.4 lbs)	
Hose Connections	19 mm (¾")	
Minimum Wire Size	1.5 mm² (16 AWG)	
Materials	Pump Body: Aluminium, Glass-filled Nylon, Clamp Ring: Acetal Diaphragm: Santoprene®, Valves: Nitrile®, Feet: EPDM Gearwheel: Delrin®, Fasteners: Stainless Steel, Brass	
Materials in Contact With Fluid	Glass-filled Nylon, Nitrile®, Santoprene®, Stainless Steel	
Accessories	Grey Waste Tanks (see page 98)	
Service Kit	AK1550 - Gulper® 220 Service Kit Contains: Diaphragm and Valves	
Maximum Suction Lift	3 m (10 ft)	
Maximum Discharge Head	3 m (10 ft)	
Maximum Discharge Head and Suction Lift (combined)	4 m (13.5 ft)	
Dry Running Current	2.4 amps	1.2 amps

Performance Data

	BP1552 / BP1554	BP1552 / BP1554
	Suction Lift	0 m (0 ft)
Discharge Head	1 m (3 ft)	1 m (3 ft)
Flow Rate per Minute	13.4 ltrs (3.5 US gals)	12.6 ltrs (3.4 US gals)
Current Draw	3.5 amps (12 V d.c.) 1.75 amps (24 V d.c.)	4 amps (12 V d.c.) 2 amps (24 V d.c.)

* based onWhale lab tests at zero head lift and zero head

Note: These specifications are retail items only.

For details of our bulk pack range for boat builders and wholesalers - contact Whale Support.

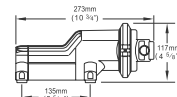

Side View

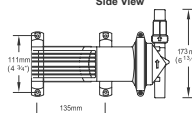

Plan View

WARNING
 Gulper® 220 is not suitable for pumping diesel. For this application please contact Whale for information.

Now with barbed outlet (discharge) connections to allow a choice of connecting directly to either ¾" (19 mm) or 1" (25 mm)

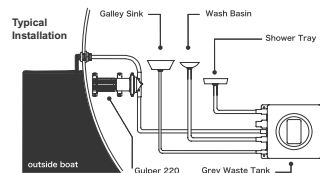

Grey Waste Tanks

Whale's Largest Range of Multi-port Grey waste tanks ever!

Simple system - Allows you to manage all grey waste on board through one thru hull fitting

Resilient polyethylene one piece moulded tanks designed to handle grey waste on board - ideal for use with Gulper® Grey Waste pumps for unbeaten debris handling

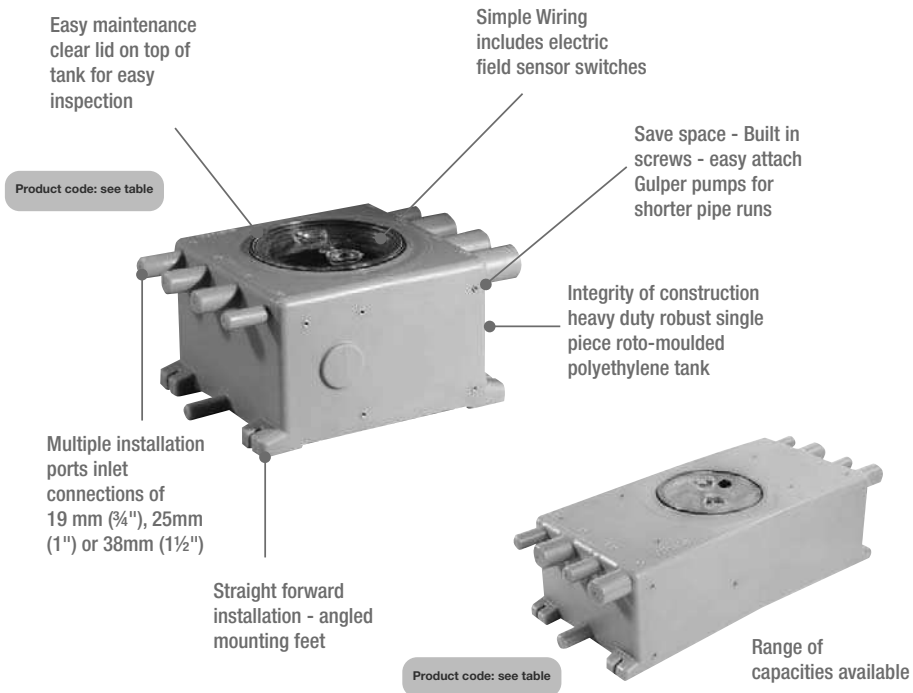

Features and Benefits

Now includes a built in Whale Switch for automatic operation and is easy to connect to any 12V/24V pump up to 20 amp

- Clear lid sits flush to top of the tank for easy inspection
- Neoprene seal prevents odour leakage
- Ideal for use with either Gulper® 320 or Gulper® 220 grey waste pumps
- Shorter pipe runs
- to mount the Gulper pump of your choice
- Capacity range from 8 ltrs / 2.2 US gals, 16 ltr (4.4 US gals) and new 100 ltr boat builder system see page 98
- Easy installation with angled feet
- Models available with either prewired deutsch connections or standard tinned wire

1 Year Warranty

COMPLETE YOUR SYSTEM

See Page 102-103 for Grey waste accessories

YOU MAY ALSO LIKE

Gulper 220 and 320 electric grey waste pumps - page 96 and 94
Whale Grey waste tank and pump systems – page 100

Product Information

HIGH CAPACITY FOR MULTIPLE DRAINS

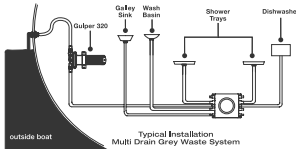

8ltrs

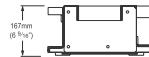

Side View

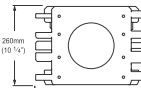

Plan View



16ltrs

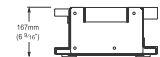

Side View

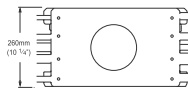

Plan View

Model Specifications

Model	8 Litre/ 2.2 US Gals Capacity Tanks		16 Litre/ 4.4 US Gals Capacity Tanks	
	GW0810	GW0831	GW1610	GW1631
Capacity	8 ltrs (2.2 US gals)		16 ltrs (4.4 US gals)	
Electrical Connectors	tinned wire ends	Deutsch x 1 DT06-3S CE06	tinned wire ends	Deutsch x 1 DT06-3S -CE06
Voltage	12 V d.c./ 24 V d.c.			
Inlet Hose Connections	19mm (3/4") x 2 25mm (1") x 3 38mm (1 1/2") x 3		25mm (1") x 4 38mm (1 1/2") x 4	
Outlet Hose Connections	19mm (3/4") x 1 25mm (1") x 1		25mm (1") x 2	
Materials	Main body: polyethylene, Seals: Neoprene, Lid: Polycarbonate			

Note: These specifications are retail items only.
For details of our bulk pack range for boat builders and wholesalers - contact Whale Support.

Shower and sink waste systems

New shower and sink waste systems

All the benefits of Whale Gulper®
Pumps and grey waste tanks
– in a pre assembled kit

Features and Benefits

Why Grey waste tanks and pump complete systems?

SIMPLE INSTALLATION Only one thru hull fitting is required for all grey waste from multiple drains

SAVE SPACE – pumps mounted onto tanks saves valuable space on board, allowing more flexibility for layouts

Switch: Electronic switch for automatic operation

Configuration: Three independent switches. Lower switch controls Pump 1 and mid level switch controls Pump 2. This ensures that Pump 2 only runs when demand is high, or when back up is required. Third sensor is high level alarm.

See page 94 for dimensions for the high capacity non clog Gulper® 320

1 Year Warranty

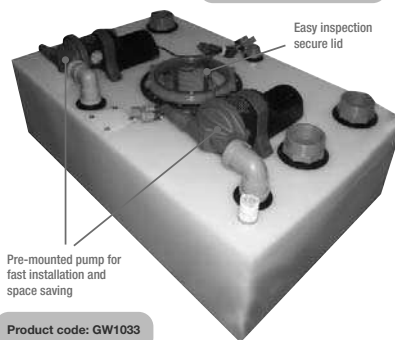

Pre-mounted pump for fast installation and space saving

Product code: GW1033

COMPLETE YOUR SYSTEM

See Page 102-103 for Grey waste accessories

YOU MAY ALSO LIKE

Gulper 220 and 320 - page 96 and 94

Multi-port Polypropylene Grey Waste tanks - page 98

Product Information

Switch: Electronic switch, no movement, no exposed contacts, 20Amp rating

Configuration: Three independent switches. Lower switch controls Pump 1 and mid level switch controls Pump 2. This ensures that Pump 2 only runs when demand is high, or when back up is required. Third sensor is high level alarm

Material: MDPE
Typical Wall Thickness 8mm
Length: 830 mm
Width: 530 mm
Height 240 mm
Ports: 4 x 2" BSP ports
1 x 1" BSP ports
1 x 3/4" barbed 360 deg rotatable (vent line)

Connections:
Deutsch Connectors x 2 – 24V supply to pump & switch 1, and 24V supply to pump & switch 2 (as per existing tanks)

Please note
this product is currently only available to boat builders
– minimum order quantities may apply
– contact Whale Support for details

Shower and Sink Waste System

GREY WASTE

Includes 8 litre (2.2 US gals) tank and Gulper 220 pump

1 Year Warranty

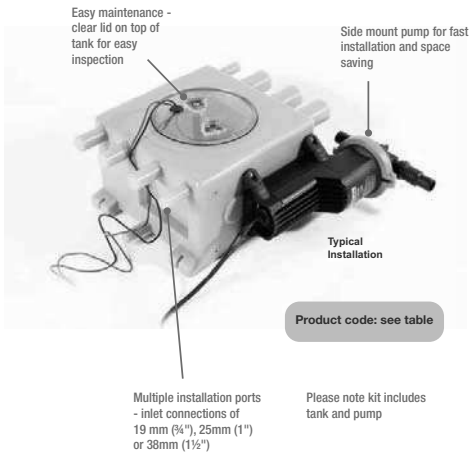

Features and Benefits

Includes 8 litre (2.2 US gals) tank and Gulper 220 pump

- No filter required (proven debris handling)
- Can run dry without damage
- Automatic pump activation
- Robust polyethylene tank design (one piece roto-moulded)

COMPLETE YOUR SYSTEM

See Page 102-103 for Grey waste accessories

YOU MAY ALSO LIKE

Gulper 220 and 320 - page 96 and 94

Multi-port Polypropylene Grey Waste tanks - page 98

i Product Information

Model	Grey Waste System
CK1512	Kit includes 8 litre (2.2 US gals) capacity grey waste tank and BP1552 Gulper 220 grey waste pump (12 V d.c.)
CK1514	Kit includes 8 litre (2.2 US gals) capacity grey waste tank and BP1554 Gulper 220 grey waste pump (24 V d.c.)

Grey / Shower Waste Accessories

Complete Your System

Fit Whale® high quality pumps and accessories to ensure long term reliability throughout your grey waste system. Whale® switches, diverter valves, and pipework connections are designed and manufactured with highest quality at heart. Combine these accessories with your Whale® waste pumps for reliability and durability.

**Need specific advice on your system? Contact our technical team at Whale support
See below for a full list of accessories**

Switches - For replacements for Whale grey waste tanks (see page 40)

Grey Waste Tank Switches

NEW Electric Field Sensor Range

- Electric field sensor automatically sense water levels and switch on the bilge pumps
- Automatically switches on when 51mm (2") of water is sensed and turns off when water drops below 13mm (½")
- BE9006 model - built in 30 second off delay for efficient operation, prevents cycle in small sump installations or enables lower drain than 13mm (½")

Model Specifications

Model	Electric Field Sensor Switch	Electric Field Sensor Switch with time delay
Product Number	BE9003	BE9006
Voltage D.C.	12V or 24V	
Current	Suitable for up to 20 Amps	
Residual Current	0.008 Amp	

Suitable for Orca and supersub standard submersible ranges - page 20 and 18

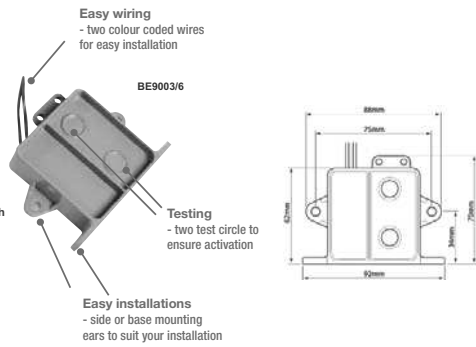

Diverter Valve

Accessories - For manual and / or electric bilge pumps

Diverter Valves

- allows one pump to draw from 2 locations

DV5630 Diverter Valve 1" (25mm) connections

DV5606 Diverter valve 1 1/2" (38mm) connections

- Materials - Main Body: Acetal, Teflon, Handle PTFE polyester
- Complies with US Coast Guard rules for type III Waste systems



DV5606
For dimensions see page 40 to 42

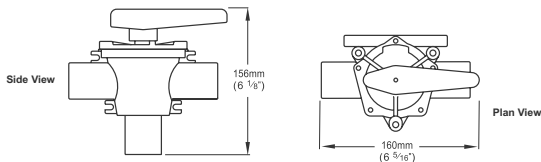

Accessories - Pipework Connections

Whale supply a wide range of accessories designed specifically for use with Whale Pumps, creating a system solution for the installer.

Y Piece

- Designed to enable two pumps to discharge through a single line
- Ideal for use when a diverter is not required

Model Specifications

Model Product Code	Y Piece YP6130	Y Piece YP6114
Pipe Diameter	13 mm (½")	38 mm (1½")
Materials	Acetal	Polypropylene



Elbows

- Ideal for use in installations in confined spaces

Model Specifications

Model Product Code	Elbow EB3364	Elbow EB3488
Pipe Diameter	25 mm (1")	38 mm (1½")
Materials	Polypropylene	



Non-Return Valves

- Provide an easy way to maintain prime in a suction or discharge line
- Designed to fit in-line
- Suitable for use with manual or electric pumps

Model Specifications

Model Product Code	Non-Return Valve LV1215	Non-Return Valve Barbed Connections LV1219
Pipe Diameter	25 mm (1") 38 mm (1½")	19 mm (¾") or 25 mm (1")
Materials	Body: Polypropylene, Valve: Nitrile®	



Skin Fittings

- Manufactured in strong high quality moulded non-corrosive acetal

Model Specifications

Model Product Code	Skin Fitting SF5018	Skin Fitting SF5131	Skin Fitting SF5204	Skin Fitting SF5425
Diameter Size	16 mm (¾")	19 mm (¾")	25 mm (1")	38 mm (1½")
Materials	Acetal			



SF5204
(see table for part numbers of other hose connections)

Note: These specifications are retail items only.
For details of our bulk pack range for boat builders and wholesalers - contact Whale Support.



Whale - Fishbox and Baitwell



Our non-clog filter free Gulper® electric waste pumps for fishbox and baitwell installations handle fish waste, and ensure long term reliability. Unlike macerator pumps, they can run dry with no risk of motor burn out. Gulper® valve technology has been built on more than a decade of market leading pump technology for proven reliable waste management.

Gulper Grouper Fishbox Evacuation Pump

- (suitable for standard 1" (25mm) or 1 1/2" (38mm) hose connections) - Page 106-107

Gulper 320 Fishbox Evacuation Pump

- (suitable for 3/4" / (19mm) or 1" / (25mm) standard hose connections) - Page 108-109

Accessories

- Complete the system with pipework fittings such as elbows, y pieces and strum boxes/strainers - refer to bilge accessories - Page 40-43

Gulper® Grouper

Fishbox evacuation pump 1" (25mm) or 1 1/2" (38mm) standard hose connections

Built on more than a decade of market leading pump technology. Unlike macerator pumps, Gulper valve technology means no filters, no clogging or motor burn out, just reliable waste management.

Pumps out fishbox, livewell and baitwell waste without clogging



Non choke valves in pump head designed to handle fish waste - no motor to clog or burn out

Reliability contains single heavy duty diaphragm for heavy duty use

Diaphragm technology no impeller to clog or burn

Product code: see table

Straight forward installation multi directional head rotates 360° for convenient installation

Simple plumbing designed for connection to heavy duty hose 1" (25mm) / 1 1/2" (38 mm) hose size

Features and Benefits

- You can depend on diaphragm pump technology : No impeller to clog or burn
- Non-choke valves- easily handle fishbox waste
- Save money - Single pump for multiple wells
- Easy to install - 360 degree head rotation and choice of 1" (25mm) or 1 1/2" (38mm) hose connections
- Easy to maintain and clean
- Ideal replacement for macerator pumps
- Fast pump out - up to 6.75 US gals/ 25.5 ltrs per minute
- Long term durability - runs dry without damage
- Save battery - Low power consumption

1 Year Warranty

Awards and Accreditations

- ISO10133 Electrical systems – extra low voltage dc installations
- Ignition protected ISO8846.
- CE marked
- IP45 rated

COMPLETE YOUR SYSTEM

See page 40-43 for accessories including pipework elbows and y pieces.

YOU MAY ALSO LIKE

Gulper 320 - page 108-109
 Fishbox evacuation pump
 (suitable for standard 1" / 1 1/2" hose connections)

i Product Information

Model Specifications

Model Product Code	Gulper® Grouper Fishbox Discharge Pump	
	BP4572	BP4574
Voltage	12 V d.c.	24 V d.c.
Recommended Fuse Size Automotive	10 amp	5 amp
Minimum Wire Size	1.5 mm ² (16 AWG)	
Weight	1.6 kg (3.5 lbs)	
Hose Connections	25 mm (1") or 38 mm (1 1/2")	
Materials	Pump Body: Aluminium, Glass-filled Nylon, Clamp Ring: Acetal Diaphragm: Santoprene®, Valves: Nitrile®, Feet: EPDM Gearwheel: Bronze, Fasteners: Stainless Steel, Brass	
Materials in Contact With Fluid	Glass-filled Nylon, Nitrile, Santoprene®, Stainless Steel	
Maximum Suction Lift	3 m (10 ft)	
Maximum Discharge Head	3 m (10 ft)	
Maximum Discharge Head and Suction Lift (combined)	4 m (13.5 ft)	
Flow Rate per Minute	25.5 ltrs or 21.8 ltrs (6.75 US gals) or (5.75 US gals)	
Dry Running Current	5 amps	2.5 amps
Service Kit	AK1557 - service kit head	

Performance Data

Suction Lift	0 m (0 ft)	1 m (3 ft)
Discharge Head	1 m (3 ft)	1 m (3 ft)
Flow Rate per Minute	22 ltrs (5.8 US gals)	19 ltrs (5 US gals)
Current Draw	6.2 amp (12 V d.c.) 3.1 amp (24 V d.c.)	9.7 amp (12 V d.c.) 4.85 amp (24 V d.c.)

Note: These specifications are retail items only.
 For details of our bulk pack range for boat builders and wholesalers - contact Whale Support.

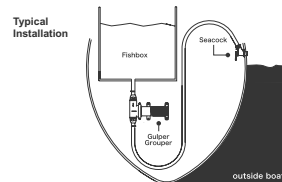
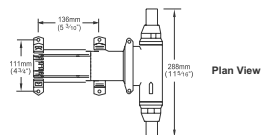
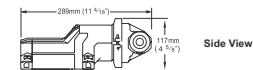

Gulper® 320

No clog, no filter waste pump built on more than a decade of market leading pump technology

Unlike macerator pumps, Gulper valve technology means no filters, no clogging or motor burn out, just reliable waste management

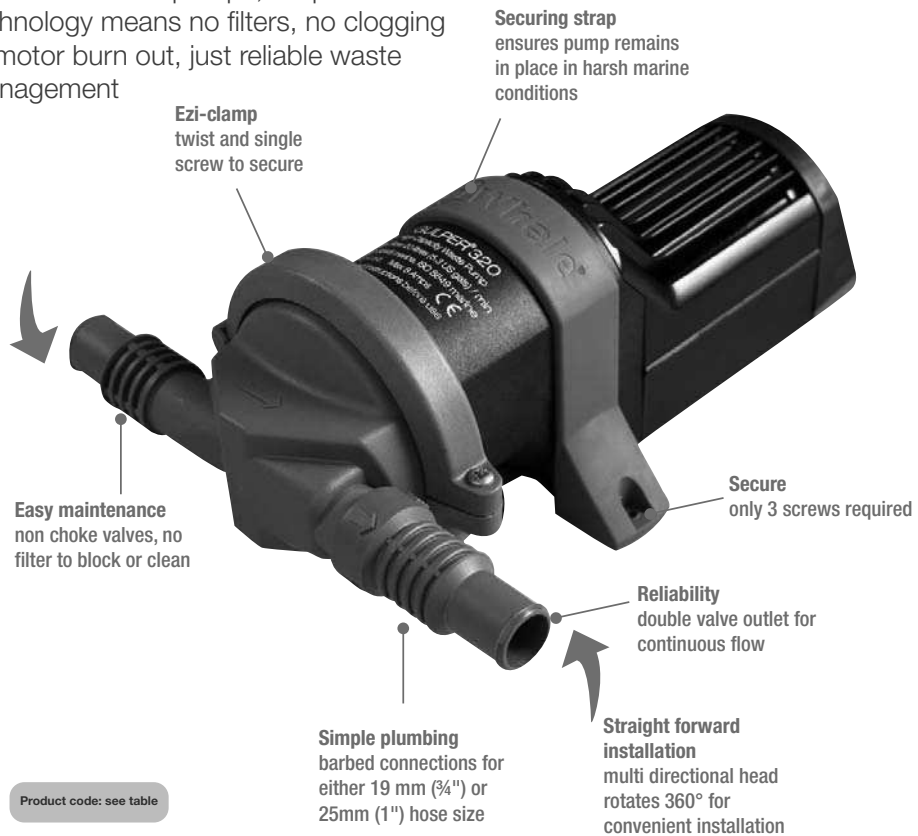

Features and Benefits

- Fishbox Discharge Pump
 - Handles fishbox waste
 - Easy to install in convenient locations
- Long term durability - runs dry without damage
- Fit in convenient locations
 - Multi-directional head position
- Save battery - Low power consumption

3 Year Warranty

Awards and Accreditations

- Ignition protection ISO8846.
- CE marked.

COMPLETE YOUR SYSTEM

See Page 40-43 for fishbox baitwell accessories

YOU MAY ALSO LIKE

Gulper Grouper - page 106

FISHBOX / BAITWELL

i Product Information

Model Specifications

Model	Gulper® 320	
Product Code (retail)	BP2052	BP2054
Voltage	12 V d.c.	24 V d.c.
Hose Connections	3/4" (19mm) + 1" (25mm)	
Recommended Fuse Size	10 Amp Automotive	5 Amp Automotive
Minimum Wire Size	1.5 mm ² (16 AWG)	
Weight	1.6 kg (3.5 lbs)	
Materials	Pump Head: Glass-filled Nylon, Valves and Diaphragm: Santoprene®	
Accessories	Service Kit: AK2050 - replacement pump head	
Maximum Suction Lift	3m (10ft)	
Maximum Discharge Head	3m (10ft)	
Maximum Discharge Head and Suction Lift Combined	4m (13.5ft)	

Performance Data

Model	BP2052 / BP2054			
Suction Lift	0m (0ft)	0m (0ft)	1m (3ft)	1m (3ft)
Discharge Head	1m (3ft)	1m (3ft)	1m (3ft)	1m (3ft)
Hose Size	3/4" (19mm)	1" (25mm)	3/4" (19mm)	1" (25mm)
Flow Rate per Minute	19 ltrs (5 US Gals)	17.5 ltrs (4.6 US Gals)	17.4 ltrs (4.5 US Gals)	15.5 ltrs (4.1 US Gals)
Current Draw	7.5 amps (12 V.d.c.) 3.25 amps (24 V.d.c.)	8 amps (12 V.d.c.) 4 amps (24 V.d.c.)	7.5 amps (12 V.d.c.) 3.25 amps (24 V.d.c.)	8 amps (12 V.d.c.) 4 amps (24 V.d.c.)

Note: These specifications are retail items only.
For details of our bulk pack range for boat builders and wholesalers - contact Whale Support.

NO IMPELLER TO CLOG/ BURN

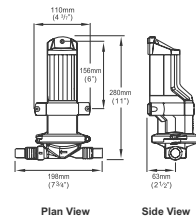
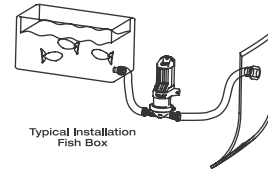



Whale - Black Waste Range

Electric / Manual Black Waste Pump Out

Practical solutions to waste management on board



Electric Black Waste Pumps

Our non-clog filter free Gulper electric waste pumps for black waste / toilet management handle un-macerated waste, and ensure long term reliability. Unlike macerator pumps, they can run dry with no risk of motor burn out. Gulper valve technology has been built on more than a decade of market leading pump technology for proven reliable waste management.

Manual Pumps

The Mark 5 sanitation is built on more than 60 years of experience. At Whale we design and build manual pumps that are reliable and can be depended on for long term durability and are backed up with spares and excellent customer service.

Electric Black Waste Pump

- Gulper Toilet Pump - Page 112-113

Manual Black Waste Pump

- Mk V Sanitation Pump - Page 114-115

Accessories

Complete the system with pipework elbows, y pieces, and strum box or strainers - Page 116-117

Gulper[®] Toilet Pump

Whale Gulper[®] Toilet Pump

For holding tank electric pump out/discharge

No clog, no filter waste pump built on more than a decade of market leading pump technology
- Pumps un-macerated toilet waste

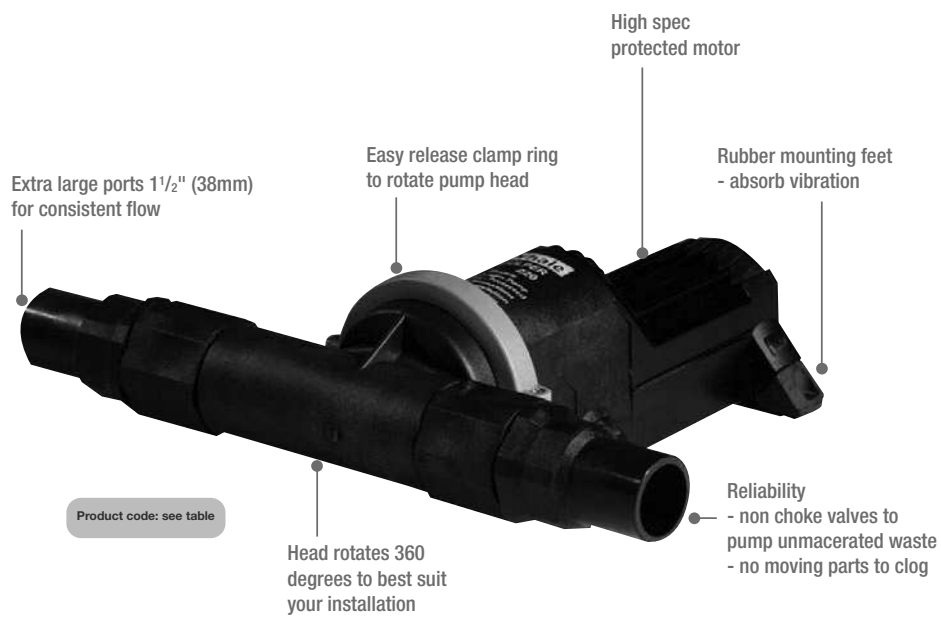

Features and Benefits

- Pumps un-macerated toilet waste
- Runs dry without damage
- Up to 18 ltrs (4.75 US gal) per minute
- Virtually unblockable
- Rotatable inlet and outlet - allows you to install in awkward locations
- Self priming up to 3 m (9.8 ft) - mount the pump in the most convenient part of boat
- Pumps a mixture of air and waste
- Easy to maintain
- Ideal for holding tanks and vacuum systems

1 Year Warranty

Tips

Ideal for use in conjunction with Whale's robust and durable Diverter Valve 1 1/2" ports - DV5606 - page 116-117



BLACK WASTE

Awards and Accreditations

- Ignition protection ISO8846
- CE marked

YOU MAY ALSO LIKE

Mark V - Manual Sanitation Pump - page 114

Bilge IC - Pre-wired Automatic bilge system with intelligent control built in - page 16

Grey IC and Gulley IC - Automatic Grey waste pump kits with automatic intelligent control built in - pages 90 and 92

i Product Information

Model Specifications

Model	Gulper® Toilet Pump	
	BP2552B	BP2554B
Product Code	BP2552B	BP2554B
Voltage	12 V d.c.	24 V d.c.
Recommended Fuse Size	10 amp Automotive	5 amp Automotive
Weight	2.12 kg (4.75 lbs)	
Hose Connections	38 mm (1 1/2")	
Minimum Wire Size	1.5 mm ² (16 AWG)	
Materials	Pump Body: Aluminum, Glass-filled Nylon, Clamp Ring: Acetal Diaphragm: Santoprene®, Valves: Nitrile, Gearwheel: Bronze Feet: EPDM, Fasteners: Stainless Steel, Brass	
Service Kit	AK1557- Service Kit	
Materials In Contact With Fluid	Glass-filled Nylon, Santoprene®, Nitrile	
Maximum Suction Lift	3 m (10 ft)	
Maximum Discharge Head	3 m (10 ft)	
Maximum Suction Lift and Discharge Head (combined)	3 m (10 ft)	
Dry Running Current	5.5 amps	2.25 amps

Performance Data

	BP2552B / BP2554B	
	BP2552B	BP2554B
Suction Lift	0 m (0 ft)	1 m (3 ft)
Discharge Head	1 m (3 ft)	1 m (3 ft)
Flow Rate per Minute	17.5 ltrs (4.6 US gals)	16.5 ltrs (4.4 US gals)
Current Draw	6.5 amp (12 V d.c.) 3.25 amp (24 V d.c.)	7.1 amp (12 V d.c.) 3.55 amp (24 V d.c.)

Note: These specifications are retail items only.
For details of our bulk pack range for boat builders and wholesalers - contact Whale Support.

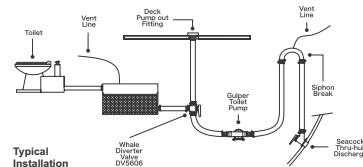

Typical Installation

Note: Where discharge is below the water line, a siphon break must be fitted.

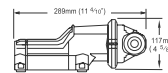

Side View

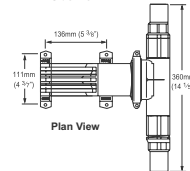

Plan View



WARNING
It is important to ensure that a syphon break is fitted, where discharge is below the water line.

Mark V – Manual Sanitation Pump

The manual black waste pump designed for toilet flush, or holding tank pump out

Designed to ensure total reliability in black waste pump out. Totally sealed unit ensures no nasty odours

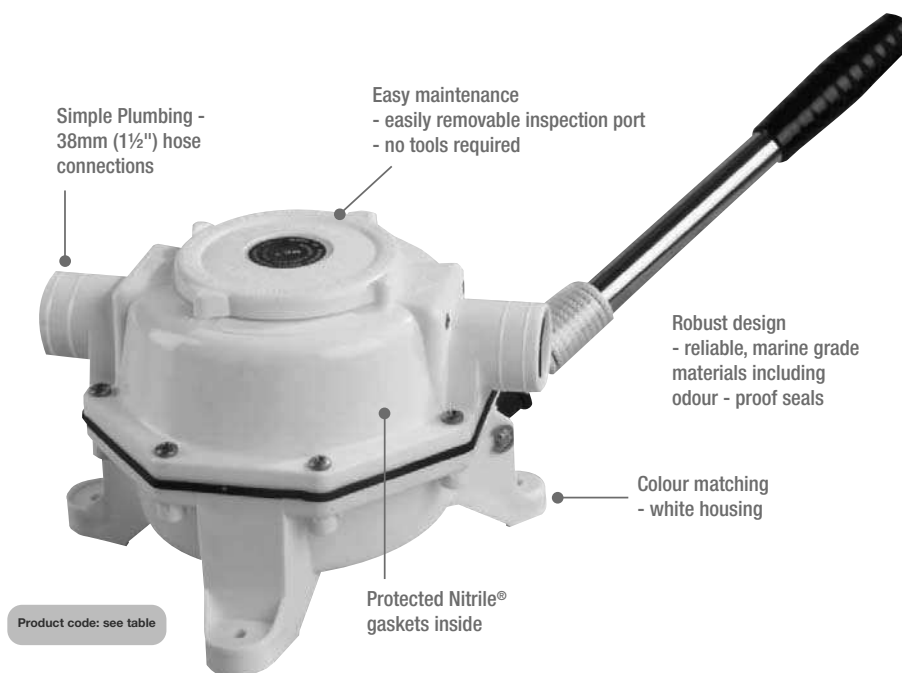

Features and Benefits

- Tough plastic housing keeps in nasty smells
- Large virtually non-block valves
- Easy to clean (no tools required)
- Maximum performance - wide hose connections 38 mm (1 1/2"), 66 ltrs (17.5 US gals) per minute
- Lightweight design for easy operation

5 Year Warranty

Tips

Ideal for use in conjunction with Whale's robust and durable Diverter Valve 1 1/2" ports - DV5606 - page 116-117

YOU MAY ALSO LIKE

Gulper Toilet Pump - Electric Black Waste Pump - page 112
 Bilge IC - Pre-wired Automatic bilge system with intelligent control built in - page 16
 Grey IC and Gulley IC - Automatic Grey waste pump kits with automatic intelligent control built in - pages 90 and 92

BLACK WASTE

Product Information

Model Specifications

Model	Mk5 Bulkhead BP0527	Mk5 Thru Deck BP0535
Product Code	BP0527	BP0535
Weight	1.17 kg (2.6 lbs)	
Hose Connections	38 mm (1 1/2") Hose Connections	
Materials	Pump Body: Glass-filled Polypropylene, Acetal Diaphragm and Seals: Nitrile, Operating Lever: Glass-filled Nylon Handle, Spring and Fasteners: Stainless Steel	
Materials In Contact With Fluid	Glass-filled Polypropylene, Acetal, Nitrile, Stainless Steel	
Service Kit	AK8050 - Service Kit for Mk5 Sanitation Contains: Diaphragms, Valves and Circlips	
Accessories	DP9905 - Deck Ring - for BP0535 only	
Maximum Suction Lift	4.5 m (15 ft)	
Maximum Discharge Head	4.5 m (15 ft)	

Performance Data

Suction Lift	1 m (3 ft)
Discharge Head	0.5 m (1.5 ft)
45 Strokes per Minute	42 ltrs (11 US gals)
70 Strokes per Minute	66 ltrs (17.5 US gals)

Note: These specifications are retail items only.
 For details of our bulk pack range for boat builders and wholesalers - contact Whale Support.

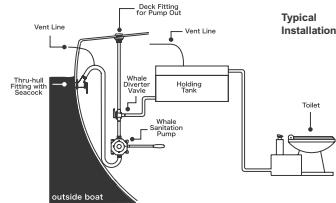

Note: Where discharge is below the water line, a siphon break must be fitted.

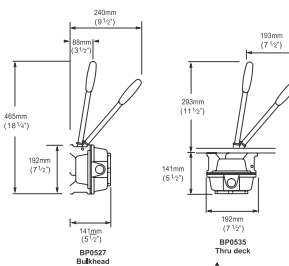

WARNING
 It is important to ensure that a syphon break is fitted, where discharge is below the water line.

Black Accessories

Black / Toilet Waste Accessories

Complete Your System

Fit Whale high quality pumps and accessories to ensure long term reliability throughout your black waste system. Diverter valves, and pipework connections are designed and manufactured with highest quality at heart. Combine these accessories with your whale waste pumps for reliability and durability.

Need specific advice on your system? Contact our technical team at Whale® Support
See below for a full list of accessories

Diverter Valve

Diverter Valves

- Allow you to divert flow to overboard or deck pump out

DV5630 Diverter Valve 1" (25mm) connections

DV5606 Diverter valve 1 1/2" (38mm) connections

- materials - Main Body: Acetal, Teflon, Handle PTFE polyester
- complies with US Coast Guard rules for type III Waste systems



DV5606

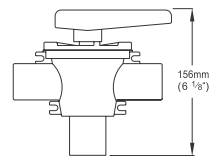

Side View

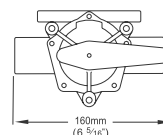

Plan View

Accessories - Pipework Connections

Whale supply a wide range of accessories designed specifically for use with Whale Pumps, creating a system solution for the installer.

Y Piece

- Designed to enable two pumps to discharge through a single line
- Ideal for use when a diverter is not required

Model Specifications

Model Product Code	Y Piece YP6130	Y Piece YP6114
Pipe Diameter	12.5 mm (½")	38 mm (1½")
Materials	Acetal	Polypropylene



Elbows

- Ideal for use in installations in confined spaces

Model Specifications

Model Product Code	Elbow EB3364	Elbow EB3488
Pipe Diameter	25 mm (1")	38 mm (1½")
Materials	Polypropylene	



Non-Return Valves

- Provide an easy way to maintain prime in a suction or discharge line
- Designed to fit in-line
- Suitable for use with manual or electric pumps

Model Specifications

Model Product Code	Non-Return Valve LV1215	Non-Return Valve Barbed Connections LV1219
Pipe Diameter	25 mm (1") 38 mm (1½")	19 mm (¾") or 25 mm (1")
Materials	Body: Polypropylene, Valve: Nitrile®	



Skin Fittings

- Manufactured in strong high quality moulded non-corrosive acetal

Model Specifications

Model Product Code	Skin Fitting SF5018	Skin Fitting SF5131	Skin Fitting SF5204	Skin Fitting SF5425
Diameter Size	16 mm (5/8")	19 mm (¾")	25 mm (1")	38 mm (1½")
Materials	Acetal			



SF5204
(see table for part numbers of other hose connections)

Note: These specifications are retail items only.
For details of our bulk pack range for boat builders and wholesalers - contact Whale Support.

Whale Support

Quick Guides

Whale Electric Bilge at a glance

Supersub Smart Family- the narrow low profile automatic bilge pumps - ideal for where bilge space is limited

Supersub Smart 650 12 V d.c.	SS5212	Page 12
Supersub 1100 Auto 12V d.c.	SS1212	Page 12
Supersub 1100 Auto 24 V d.c.	SS1224	Page 12

Orca - Auto 1300 - compact powerful and automatic - submersible bilge pump

Orca Auto - 1300 US GPH - 12 V d.c.	BE1482	Page 14
Orca Auto - 1300 US GPH - 24 V d.c.	BE1484	Page 14

Bilge IC - prewired bilge system includes remote mounted bilge pump, strainer, switch and non return valve in one pre-assembled kit

Bilge IC Retail Kit 12 V d.c. (includes Gulper IC pump and strainer IC with intelligent control built in)	SB284	Page 16
Bilge IC Retail Kit 24 V d.c. (includes Gulper IC pump and strainer IC with intelligent control built in)	SB484	Page 16

Spares - Bilge IC

Service Kit-Whale Gulper Replacement Head	AK2050	Page 16
---	--------	---------

Whale Standard Electric Bilge Pumps (designed for use with a separate bilge switch)

Supersub - the narrow low profile submersible bilge pump - ideal where space is limited

Supersub 500 - Narrow Electric Bilge Pump 12 V d.c.	SS5012	Page 18
Supersub 1100 - Narrow Electric Bilge Pump 12V d.c.	SS1012	Page 18
Supersub 1100 - Narrow Electric Bilge Pump 24 V d.c.	SS1024	Page 18

Orca - compact and Powerful standard submersible bilge pump

Orca Submersible Electric Bilge Pump 500GPH 12 V d.c.	BE0500	Page 20
Orca Submersible Electric Bilge Pump 950GPH 12 V d.c.	BE0950	Page 20
Orca Submersible Electric Bilge Pump 1300GPH 12 V d.c.	BE1450	Page 20
Orca Submersible Electric Bilge Pump 1300GPH 24 V d.c.	BE1454	Page 20
NEW Orca Submersible Electric Bilge Pump 2000GPH 12 V d.c.	BE2002	Page 20
NEW Orca Submersible Electric Bilge Pump 2000GPH 24 V d.c.	BE2004	Page 20
NEW Orca Submersible Electric Bilge Pump 3000GPH 12 V d.c.	BE3002	Page 20
NEW Orca Submersible Electric Bilge Pump 3000GPH 24 V d.c.	BE3004	Page 20

Gulper 320 - remote mount bilge pump with narrow footprint strainer - ideal for very narrow bilge areas with limited access

Gulper 320 12 V d.c. And strainer	BP2052	Page 22
Gulper 320 24 V d.c. And strainer	BP2054	Page 22

Spares - Gulper 320

Service Kit-Whale Gulper 320 Replacement Head	AK2050	Page 22
---	--------	---------

Whale Electric Bilge Switches

(designed for use with non automatic submersible bilge pumps - e.g. Supersub or Orca)

Mechanical Float Switch	BE9002	Page 40
Electric Field Bilge Switch	BE9003	Page 40
Electric Field Bilge Switch (30 sec time delay)	BE9006	Page 40

Accessories - complete the system

Divertor Valve 1" (25mm)	DV5630	Page 40
Divertor Valve 1½" (38mm)	DV5606	Page 40
Non-return valve Inline 1" (25mm) or 1 ½" (38mm)	LV1215	Page 40
Non-return valve Inline ¾" (19mm) or 1 " (25 mm)	LV1219	Page 40
Strainer - top / side entry ¾" (19mm)	SB3422	Page 40
Strainer Side entry Valve - 1" (25mm) or 1 ½" (38mm)	SB4222	Page 40
Strainer Top entry Valve 1" (25mm) or 1 ½" (38mm)	SB5665	Page 40
Hose Fitting Elbow 1" (25mm)	EB3364	Page 40
Hose Fitting Elbow 1,½" (38mm)	EB3488	Page 40
Hose Fitting Y-piece 1,½" (38mm)	YP6114	Page 40
Skifitting Plastic ¾" (19mm)	SF5018	Page 40
Skifitting Plastic ¾" (19mm)	SF5131	Page 40
Skifitting Plastic 1" (25mm)	SF5204	Page 40
Skifitting Plastic 1 ½" (38mm)	SF5425	Page 40

Whale Manual Bilge At a glance

Gusher® Range - Long Life Diecast Alloy Models

Gusher 10 - The original bilge pump choice for sailors in extreme conditions

Whale Gusher 10 Diecast Alloy Manual bilge Pump - ondeck/ bulkhead	BP3708	Page 26
Whale Gusher 10 Diecast Alloy Manual bilge Pump -Thru-deck/ Bulkhead	BP3740	Page 26

Spares - Gusher 10

Service Kit - diaphragm and valves kit (Neoprene)	AK3706	Page 26
Service Kit - diaphragm and valves kit (Nitrile- for oil and diesel)	AK3714	Page 26
Spare handle	AS4405	Page 26

Gusher 30 - Whale's highest capacity heavy duty pump ideal for when long term durability and high performance is vital

Whale Gusher 30 - high capacity diecast alloy bilge pump - on deck	BP3000	Page 28
Whale Gusher 30 - high capacity diecast alloy bilge pump - on bulkhead deck	BP3010	Page 28
Whale Gusher 30 - high capacity diecast alloy bilge pump - thru- deck	BP3020	Page 28

Spares - Gusher 30

Spare Kits - diaphragm and valves	AK3051	Page 28
Thru deck conversion kit for BP3000	AS3020	Page 28
Spare handle	AS3095	Page 28

Gusher® Range - Tough and Lightweight Polypropylene Models

Gusher Urchin - Whale's compact design ideal for high performance in confined spaces

Whale Gusher Urchin - On deck fixed handle	BP9005	Page 30
Whale Gusher Urchin - thru deck bulkhead	BP9013	Page 30
Whale Gusher Urchin - On deck removable handle	BP9021	Page 30

Spares - Gusher Urchin

AK9003 - Kit includes diaphragm, valves and fixtures (neoprene)	AK9003	Page 30
AK9011 - Kit includes diaphragm, valves and fixtures (Nitrile® - Required to Pump diesel)	AK9011	Page 30
AS8680 - Spare handle (for use with BP9013/BP9021 models)	AS8680	Page 30

Gusher Titan - The tough lightweight proven pump

Whale Gusher Titan - on deck	BP4402	Page 32
Whale Gusher Titan - thru- deck/ Bulkhead	BP4410	Page 32

Spares - Gusher Titan

Service Kit - Includes diaphragm, valves and fixtures (neoprene)	AK4400	Page 32
Service Kit - Kit includes diaphragm, valves and fixtures (Nitrile - required to pump diesel)	AK4419	Page 32
Spare handle	AS4405	Page 32

Mark V Universal - High Capacity Manual Bilge Pump

- Three mounting options- 1 pump

Whale Mark V Manual Bilge Pump	BP0510	Page 34
--------------------------------	--------	---------

Spares - Mark V

AK8050-kit includes Nitrile® diaphragm, valves and fixtures	AK8050	Page 34
---	--------	---------

Double Acting Mark V - High Capacity Manual Bilge Pump - Three mounting options- 1 pump

Double Acting Mark Pump Hend Mk5 (bulkhead)	MH5550	Page 34
Double Acting Mark Pump Hend Mk5 (underdeck)	MH5560	Page 34
Double Acting Mark Pump Hend Mk5 (on deck)	MH5570	Page 34

Spares - Mark V - Double Acting

Service kit includes Nitrile® diaphragm, valves and fixtures	AK8060	Page 34
--	--------	---------

Low Profile - Compact Range

Compac 50 - Whale's most slim line design

Compac 50 (includes deck plate)	BP0530	Page 36
---------------------------------	--------	---------

Spares - Compac 50

Service Kit for Compac 50 Contains: Diaphragm, Accessories Valves and Circlips	AK9035	Page 36
Clamping Ring Kit	AS0353	Page 36
Spare Handle	AS0355	Page 36

Smartball	
Smartball - Whale's easy install, lightweight pump design with integrated handle	BP5012 Page 38

Spares - Smartball	
Service Kit for Smartball Contains: Diaphragm, Accessorises Valves and Circlips,	AK5010 Page 38

Portable	
Easybailer - Portable pumps- the handy hand pump for easy bail out!	
Easybailer - short barrel version	BP1935 Page 39
Easybailer - long barrel version	BP1955 Page 39

Dinghy / Kayak (contact Whale)	
Chimp foot pump	MH0145

Accessories - complete the system

Deckplates	
Replacement Deckplate for Compac 50 - plastic 4 hole covered - PBT	AS0356 Page 40
Deckplate - includes bridge and DP3804 deck plate- Cast and Aluminium LM6- for underdeck	AS3020 Page 40
Deck Plate Kit- metal 4 hole With Lid (Suitable for underdeck Gusher 10)	DP3804 Page 40
- Cast and Aluminium LM6- for underdeck	
Deck Plate Kit Plastic Covered (suitable for Gusher Urchin, Gusher Titan, and Gusher 10 underdeck models) - PBT	DP8904 Page 40
Deck Plate 6 hole covered Mtg Kit Whale Mk5 Conv. (white (suitable for Mark V Universal- when fitted underdeck) - Acetal	DP9905 Page 40
Deck Plate Plastic 4 hole covered - (Suitable for Mark V when fitted underdeck) -PBT	DP9906 Page 40

Diverter Valves	
Valve Diverter 1" (25mm)	DV5630 Page 40
Valve Diverter 1 1/2" (38mm)	DV5606 Page 40
NON RETURN VALVES	
Valve Non-return In-line- 1" (25mm) or 1 1/2" (38mm)	LV1215 Page 40
Valve Non-return In-line- 3/4" (19mm) or 1" (25mm)	LV1219 Page 40

Strainers / Strum Boxes Strainers	
Strainer Side entry 1" (25mm) or 1 1/2" (38mm)	SB4222 Page 40
Strainer Top entry 1" (25mm) or 1 1/2" (38mm)	SB5665 Page 40

Pipework Connections	
Hose Fitting Elbow 1" (25mm)	EB3364 Page 40
Hose Fitting Elbow 1 1/2" (38mm)	EB3488 Page 40
Hose Fitting Y-piece 1 1/2" (38mm)	YP6114 Page 40

Skin Fittings	
Skinfitting Plstc 3/8" (16mm)	SF5018 Page 40
Skinfitting Plstc 1/2" (19mm)	SF5131 Page 40
Skinfitting Plstc 1" (25mm)	SF5204 Page 40
Skinfitting Plstc 1 1/2" (38mm)	SF5425 Page 40

Whale Freshwater system at a glance

For all your freshwater needs on board

Electric Galley Pump range

Fresh IC	
Fresh IC intelligent freshwater pump - 12 V d.c.	FW5082 Page 46
Fresh IC intelligent freshwater pump - 24 V d.c.	FW5084 Page 46

Universal	
Universal Freshwater pressure Pump - 8 ltr (2.2 US gals) (1 bar 15 psi) 12 V d.c.	UF0812 Page 48
Universal Freshwater pressure Pump - 12 ltr (3.2 US gals) (1 bar 15 psi) 12 V d.c.	UF1212 Page 48
Universal Freshwater pressure Pump - 12 ltr (3.2 US gals) (2 bar 30 psi) 12 V d.c.	UF1214 Page 48
Universal Freshwater pressure Pump - 8 ltr (2.2 US gals) (3 bar 45 psi) 12 V d.c.	UF0815 Page 48
Universal Freshwater pressure Pump - 12 ltr (3.2 US gals) (3 bar 45 psi) 12 V d.c.	UF1215 Page 48
Universal Freshwater pressure Pump - 12 ltr (3.2 US gals) (3 bar 45 psi) 24 V d.c.	UF1225 Page 48

Spares - Electric Galley Pumps	
Service kit - Whale Universal Freshwater- Replacement Head	AK1316 Page 48
Service Kit - Whale Universal Freshwater Microswitch Kit	AK1317 Page 48
Service Kit - Whale Universal Freshwater Strainer - for Universal / Fresh IC	AK1319 Page 48
Washdown pump spares kit - replacement strainer for saltwater applications	AK1329 Page 80

Accumulator Kit

- includes pump and expansion tank preassembled

Integrated Pump Accumulator Kit - with 12ltr 2 bar pump	UF2014 Page 50
Integrated Pump Accumulator Kit - with 12ltr 3 bar pump	UF2015 Page 50
Integrated Pump Accumulator Kit - with 18ltr 3 bar pump	UF8025 Page 50
Integrated Pump Accumulator Kit - with 18ltr 3 bar pump	UF8015 Page 50
note - see Universal spares kits for pump spares	

Submersible Pumps

Standard Submersible Electric Galley Pump 10 ltr/min, 2.4 amps 0.6 Bar, 12 V d.c.	GP1002 Page 52
Premium Submersible Electric Galley Pump 13 ltr / min, 3.6 amps / 1.0 Bar 12 Vd.c.	GP1352 Page 52
Premium Submersible Electric Galley Pump 13 ltr / min, 3.6 amps / 1.0 Bar 24V d.c.	GP1354 Page 52
High Flow Submersible Electric Galley Pump 16 ltrs 3.8 amps, 1.4 Bar	GP1652 Page 52

Inline Booster Pumps

Premium In line pump 13 lpm 12 V d.c.	GP1392 Page 54
Premium In line pump 13 lpm 24 V d.c.	GP1394 Page 54
High Flow In line pump 16 lpm 12 V d.c.	GP1692 Page 54

Manual Galley Pumps

Hand Operated Pumps

V pump Self priming Lever hand operated manual galley pump	GP0650 Page 56
Whale Flipper - manual galley hand operated pump	GP0410 Page 57

Foot Operated Pumps

Gusher Galley - foot operated manual galley pump right hand lever	GP0650 Page 58
Gusher Galley - foot operated manual galley pump left hand lever	GP0651 Page 58
Whale Babyfoot - compact manual galley foot operated pump	GP4618 Page 59
Tiptoe - foot operated manual galley pump (flush to floor)	GP1309 Page 60

Spares - Manual Galley Pumps

Service Kit - Whale Flipper Mk3/4	AK0405 Page 57
Service Kit - Whale Gusher Galley Mk2	AK0502 Page 58
Service Kit - Whale Gusher Galley Mk3	AK0553 Page 58
Service Kit - Whale V Pump Mk3/6	AK0618 Page 56
Service Kit - Whale Tiptoe Mk3/4	AK1304 Page 60
Service Kit - Whale Gusher Galley Mk 3 - Piston/Spring Assembly	AS0556 Page 58

Faucets

Elegance - ABS touch lightweight faucet range

Elegance Single Faucet - cold only (1/2" threaded)	RT1210 Page 69
Elegance hot/ cold mixer faucet- Long outlet spout (1/2" hose connection)	RT2207 Page 62
Elegance hot/ cold mixer faucet 1/2" (1/2" hose connection)	RT2210 Page 62

Metal Faucets

Single Lever Galley mixer (chrome)	TT1111 Page 64
Single Lever mixer (chrome) - Swan Neck Galley	TT1211 Page 64
Single lever mixer - Vanity (chrome)	TT1311 Page 64
Single Lever Shower mixer (chrome)	TT1411 Page 64
Shower Handset, riser rail and hose (chrome)	TT8011 Page 68

Tuckaway and Telescopic Faucet Range

Tuckaway Faucet angled with on/off control	FT1276 Page 64
Telescopic Faucet with on/off control	FT1160 Page 64
Telescopic control (outlet only)	FT1152 Page 64

Compact Faucet Range

Compact Range - Single faucet cold only with valve (chrome)	TB4110 Page 64
Compact Range - Mixer Faucet	TB4112 Page 64
Compact Range - Pull out galley mixer (chrome)	TB4186 Page 64
Compact range - Washdown bib/ spigot	TB4172 Page 64
Compact Range - Washdown trigger handset	TB4170 Page 64

Internal Showers

ABS Showers

Elegance Combination - pull out cold only unit (white) 1/2" threaded	RT1470 Page 69
Elegance Combination - pull out mixer unit (white) 1/2" threaded	RT2498 Page 69

Metal Showers

Modern Single lever Style- chromed brass internal shower- mixer, hose, handset and riser rail	TT8011 Page 68
Modern Single lever Style- chromed brass mixer	
Pull Out Galley mixer (chrome) 1/2" BSP	TT4180B Page 68

Whale Support

Quick Guides

Whale Deck Showers

Whale Twist® Deck Shower Cold only		
- includes both angled and vertical housing options	DS0005	Page 70
Twist Deck Shower Retail Mixer- unique integrated temperature and flow control handset (includes both angled and vertical housing options)	DS0006	Page 70
Compact Swim 'n' rinse® - with stainless steel cover - shower handset - in horizontal mount	RT2968	Page 72
Compact Swim 'n' rinse® - with stainless steel cover - shower handset - in vertical mount	RT2978	Page 72
Compact Swim 'n' rinse® - with stainless steel cover - hot/ cold mixer	RT2988	Page 72
Compact Swim 'n' rinse® - cold only with rubber splash-proof cover - with one touch trigger handset	RT3000	Page 72
Swim 'n' rinse Cold Only (no cover)	RT1248	Page 74
Swim 'n' rinse Cold Only (cover)	RT1649	Page 74
Swim 'n' rinse Hot and Cold Mixer (no cover)	RT2648	Page 74
Swim 'n' rinse Hot and Cold Mixer (cover)	RT2658	Page 74
Swim 'n' rinse Hot and Cold Mixer (lockable cover)	RT2662	Page 74

Spares - Faucets, Showers, Deck Showers

Service Kit - Whale Elegance Tap & Shower	AK5030	Page 62
Service Kit - Shower Handset For TB4180	AS4180	Page 68
Service Kit - Shower Hose Chrome 2m TB4180	AS4191B	Page 68
Service Kit - Whale Elegance Tap/Shower Control Kit Wte	AS5122	Page 62
Service Kit - Whale Elegance Combo Handset Wite	AS5123	Page 69
Service Kit - Whale Elegance Combo Handset Wite ½" Bsp	AS5133	Page 69
Service Kit - Whale Elegance Shower Hose Assembly White	AS5145	Page 69
Service Kit - Whale Elegance Shower Hose ½" Bsp White 1.7m	AS5146	Page 69
Service Kit - Whale Elegance - Hose Assembly Swim'n'rinse 2.1m Wite	AS5147	Page 74
Service Kit - Whale Elegance - Swim'n'rinse Hose ½" Bsp 2.1m	AS5148	Page 74
Service Kit - Whale Elegance - Shower Hose Connector Wite	AS5149	Page 69
Service Kit - Whale Elegance - Tap/Shower Upgrade Kit Beige	AS5626	Page 62
Service Kit - Whale Elegance - Shower Hose Assembly Beige	AS5645	Page 69
Twist storage bag - for neat storage of DS0005/ DS0006) 2.5 m models	AK0015	Page 70
Elegance faucet Microswitch Kit	RT9000	Page 62

Accessories - Complete the System

Aquasource Clear Water Filter 15mm- For refreshing tasting water on board	WF1530	Page 76
In line Pressure Switch- for use with submersible or in line self venting pumps in a pressurized water system	WU7207	Page 76
Surge Damper (15mm connections) For a smooth constant water supply	WS7215	Page 76
One Way check valves for 13mm (½") flexible hose (white)	FV1227	Page 76
- fit in line to maintain prime for short periods	FV1227	Page 76
Hose Fitting Y-piece 13mm (½") - acetal	YP6130	Page 76
Note - for Quick connect Plumbing fittings		Page 84

Whale Washdown and Locker Hatches at a Glance

Washdown Pressure Pumps

Universal Washdown Pressure Pump 12 ltr/min 12 V d.c.	UF1215	Page 80
Universal Washdown Pressure Pump 12 ltr/min 24 V d.c.	UF1225	Page 80
Universal Washdown Pressure Pump 18 ltr/min 12 V d.c.	UF1815	Page 80
Universal Washdown Pressure Pump 18 ltr/min 24 V d.c.	UF1825	Page 80

Washdown Pump and Trigger Kits

Washdown Kit (includes Universal Pressure Pump 18 ltr/ min 12 V d.c.) with trigger handset	WD1815	Page 80
Washdown Kit (includes Universal Pressure Pump 18 ltr/ min 24 V d.c.) with trigger handset	WD1825	Page 80

Spares Washdown

Service Kit - Whale Universal washdown Replacement Head	AK1316	Page 80
Service Kit - Whale Universal washdown Microswitch Kit	AK1317	Page 80
Washdown pump spares kit - Replacement strainer for saltwater applications	AK1329	Page 80

Portable Pump Kits

Portable Pump Kit - 12V d.c.	GP1642	Page 82
------------------------------	--------	---------

Locker Doors

Whale Locker Door TCL-2	LD2000	Page 83
Whale Locker Door TCL-3	LD3000	Page 83
Whale Locker Door TCL-4	LD4000	Page 83
Whale Locker Door TCL-4 Clear	LD4002	Page 83

Spares Locker Doors

Service Kit Henderson TCL4 + 2	AK4010	Page 83
Service Kit Cover & Locking Lever Kit TCL3	AS3006	Page 83
Note - for Quick connect Plumbing fittings see page 84		
for washdown faucets - see page 64 and for Twist deck shower page 70		

Accessories - Complete the System

In line Pressure Switch- for use with submersible or in line self venting pumps in a pressurized water system	WU7207	Page 76
Surge Damper (15mm connections) For a smooth constant water supply	WS7215	Page 76
One Way check valves for 13mm (½") flexible hose (white)	FV1227	Page 76
- fit in line to maintain prime for short periods	FV1227	Page 76
Hose Fitting Y-piece 13mm (½") - acetal	YP6130	Page 76

Whale Grey (shower/ sink/ dishwasher) Waste - at a glance

Whale - Grey Waste Management Systems - IC Intelligent control

Whale Grey IC Kit - for 2 drains - includes Gulper IC (12 v D.C.) - includes manifold IC	WM8284	page 90
Whale Grey IC Kit - for 2 drains - includes Gulper IC - includes manifold IC	WM8484	page 90
Whale Gulley IC Kit - for single drain - includes Gulper IC and Intelligent Shower Gulley (12 v D.C.)	SG8284	page 92
Whale Gulley IC Kit -for single drain- includes Gulper IC and Intelligent Shower Gulley (24 v D.C.)	SG8484	page 92

Whale Gulper® Electric Grey Waste Pumps

Gulper 320 - high capacity pump - 12 V d.c. (for use with a grey waste tank - see below)	BP2052	page 94
Gulper 320 - high capacity pump - 24 V d.c. (for use with a grey waste tank - see below)	BP2054	page 94
Gulper 220- Grey Waste Pump 12 V d.c. (for use with a grey waste tank - see below)	BP1552	page 96
Gulper 220- Grey Waste Pump 24 V d.c. (for use with a grey waste tank - see below)	BP1554	page 96

Spares Gulper Electric Grey Waste Pumps

Change Replacement pump head for Gulper 220	AS2050	page 96
- Gulper 320	AS2050	page 94
- Gulper IC	AS2050	page 90

Whale Multiport - Polyethylene Tanks

Whale Grey Waste Tank 8 ltr capacity with 1 switch 12 v / 24 v	GW0810	page 98
Whale Grey Waste Tank 8 ltr capacity - Deutsch x 1 DT06-3S	GW0831	page 98
Whale Grey Waste Tank 16 ltr capacity with 1 switch 12 v / 24 v	GW1610	page 98
Whale Grey Waste Tank 16 ltr capacity - Deutsch x 1 DT06-3S	GW1631	page 98

Whale Grey Waste Pre-Assembled Kits

- Gulper pumps and Multiport - Polyethylene Tanks

Whale Grey Waste Tank 100 ltr capacity with 2 installed Gulper 320 pumps 24 V d.c. (note - available to boat builders only)	GW1033	page 100
Whale Grey Waste Tank 100 ltr capacity with 2 installed Gulper 320 pumps 24 V d.c. (note - available to boat builders only)	GW1003	page 100
Shower and Sink Waste System - preassembled		
Gulper 220 and 8 ltr tank kit - 12 V d.c.	CK1512	page 101
Shower and Sink Waste System - preassembled Gulper 220 and 8 ltr tank kit - 24V d.c.	CK1514	page 101

Accessories - Complete the System

Diverter Valve 1" (25mm) connections	DV5630	page 102
Diverter valve 1 ½" (38mm) connections	DV5606	page 102
Non-return Valve Inline 1" (25mm) or 38mm (1 ½") connections	LV1215	page 102
Non-return Valve Inline ¾" (19mm) or 25mm (1") connections	LV1219	page 102
Strainer - ¾" (19mm) multidirectional port includes non-return valve	SB3422	page 102
Strainer- side entry 1" (25mm) or 1 ½" (38mm)-	SB4222	page 102
Strainer top entry - (25mm) or 1 ½" (38mm) -	SB5965	page 102
Hose Fitting Elbow 1" (25mm)	EB3364	page 102
Hose Fitting Elbow 1 ½" (38mm)	EB3488	page 102
Hose Fitting Y-piece 1 ½" (38mm)	YP6114	page 102
Skinfitting ¾" (19mm)	SF5018	page 102
Skinfitting ¾" (19mm)	SF5131	page 102
Skinfitting 1" (25mm)	SF5204	page 102
Skinfitting 1 ½" (38mm)	SF5425	page 102

Whale Fishbox/ Baitwell Waste - at a Glance

Whale Gulper® Electric Fishbox/ Baitwell Pumps

Gulper Grouper - Fishbox evacuation pump (12 V d.c.)	BP4572	page 106
Gulper Grouper - Fishbox evacuation pump (24 V d.c.)	BP4574	page 106
Gulper 320 Diaphragm Fishbox Waste Pump 12 V d.c.	BP2052	page 106
Gulper 320 Diaphragm Fishbox Waste Pump 24 V d.c.	BP2054	page 106

Spares- Gulper Electric Fishbox/ Baitwell Pumps

Replacement head for Gulper Grouper	AK1557	page 106
Replacement pump head for Gulper 320 ONLY	AK2050	page 106

ACCESSORIES - complete the system

Diverter Valve 1" (25mm) connections	DV5630	page 40
Diverter valve 1 1/2" (38mm) connections	DV5606	page 40
Non-return Valve Inline 1" (25mm) or 38mm (1 1/2") connections	LV1215	page 40
Non-return Valve Inline 3/4" (19mm) or 25mm (1") connections	LV1219	page 40
Strainer - 3/4" (19mm) multidirectional port includes non-return valve	SB3422	page 40
Strainer- side entry 1" (25mm) or 1 1/2" (38mm)	SB4222	page 40
Strainer top entry - (25mm) or 1 1/2" (38mm)	SB3665	page 40
Hose Fitting Elbow 1" (25mm)	EB3364	page 40
Hose Fitting Elbow 1 1/2" (38mm)	EB3488	page 40
Hose Fitting Y-piece 1 1/2" (38mm)	YP6114	page 40
Skinfitting 3/8" (16mm)	SF5018	page 40
Skinfitting 1/2" (16mm)	SF5131	page 40
Skinfitting 1" (25mm)	SF5204	page 40
Skinfitting 1 1/2" (38mm)	SF5425	page 40

Whale Black (toilet) Waste - at a Glance

Whale Gulper® non-clog electric black waste pumps and robust manual sanitation pumps

Whale Gulper® Electric Toilet Waste - Discharge Pump out Waste Pumps

Gulper Toilet Pump - holding tank electric pump out 12V d.c.	BP2552B	page 112
Gulper Toilet Pump - holding tank electric pump out 24 V d.c.	BP2554B	page 112

Spares - Gulper Electric Toilet Waste - Discharge Pump out Waste Pumps

Service Kit- Whale Gulper® Toilet Pump- Diaphragm, valves and fasteners	AK1557	page 112
Service Kit - Whale Gulper® Toilet Pump- Clamping Ring Kit	AS1562	page 112

Whale Manual Sanitation - Mark V pump

Mk 5 Sanitation manual black waste pump (bulkhead mount)	BP0527	page 114
Mk 5 Sanitation manual black waste pump (thru-deck mount)	BP0535	page 114

Spares - Manual Sanitation - Mark V pump

Service Kit -Whale Mark5 Sanitation - Diaphragm, valves and fasteners	AK8050	page 114
Service Kit -Whale Mark5 Sanitation - Handle assembly 330mm	AS0511	page 114
Service Kit - Whale Mark 5 Sanitation - Rocker Arm Assembly	AS0521	page 114
Service Kit -Whale Mark 5 Sanitation - Front Cover/Body Assembly	AS0522	page 114
Service Kit - Whale Mark5 Sanitation - Diaphragm Plate/Pivot Arm Kit	AS0561	page 114

ACCESSORIES - Complete the System

Diverter valve 1 1/2" (38mm) connections	DV5606	page 116
Hose Fitting Elbow 1 1/2" (38mm)	EB3488	page 116
Hose Fitting Y-piece 1 1/2" (38mm)	YP6114	page 116
Skinfitting 1 1/2" (38mm)	SF5425	page 116

A Full List of Spares Kits – at a Glance

Bilge - Spares

Gulper Electric Bilge

Service Kit-Whale Gulper 320 Replacement Head	AK2050	page 22
---	--------	---------

Gusher 25/30 Manual Bilge Pump

Service Kit Whale Gusher 25 Neoprene diaphragm, valves and fasteners	AK3051	page 28
Service Kit Whale Gusher 25 Nitrile® diaphragm, valves and fasteners	AK3528	page 28
Service Kit - Whale Gusher 30 - Lever Assembly	AS3015	page 28
Service kit - Whale Gusher 30 -Handwheel/Stud Kit	AS3016	page 28
Service Kit - Galter Kit For Deckplates (for underdeck models - Gusher 30 and 10, Titan, Urchin, MarkV)	AS3725	page 28
Service Kit - Whale Deck Plate Conversion kit -for Gusher 30	AS3020	page 28

Gusher 10 Manual Bilge Pump

Service Kit Whale Gusher 10 Mk2/3 Neoprene - diaphragm, valves and fasteners	AK3706	page 26
Service Kit Whale Gusher 10 Mk2/3 Nitrile® - diaphragm, valves and fasteners	AK3714	page 26
Service Kit- Whale Gusher 10 - Eyebolt/Clamp Plate Assembly	AS3719	page 26
Service Kit - Whale Gusher 10 - Outlet Valve Plate Assembly	AS3723	page 26
Service Kit - Whale Gusher 10 - Fork Assembly	AS3780	page 26
Service kit - Whale Gusher 10 / Titan - Handle assembly 330mm + Lanyard	AS4405	page 26
Service Kit - Galter Kit For Deckplates (for underdeck models - Gusher 30 and 10, Titan, Urchin, Mark5)	AS3725	page 40

Gusher Titan Manual Bilge Pump

Service Kit - Whale Gusher Titan Neoprene diaphragm, valves and fixings	AK4400	page 32
Service Kit - Whale Gusher Titan Nitrile® diaphragm, valves and fixings	AK4419	page 32
Service Kit - Whale Gusher Titan - Standard Lever Kit	AS4406	page 32
Service Kit - Whale Gusher Titan - Standard Clamping Ring Kit	AS4407	page 32
Service Kit - Whale Gusher Titan- Operating Lever U/Deck	AS4408	page 32
Service kit - Whale Gusher Titan - UnderDeck Clamping Ring Kit	AS4409	page 32
Service Kit - Whale Gusher Titan - Clamping Plate Kit	AS4412	page 32
Service Kit - Galter Kit For Deckplates (for underdeck models - Gusher 30 and 10, Titan, Urchin, MarkV)	AS3725	page 40

Smartball Manual Bilge Pump

Service Kit - Whale Smartball - diaphragm, valves and fasteners	AK5010	page 38
---	--------	---------

Compac 50 Manual Bilge Pump

Service Kit Whale Compac 50 - diaphragm, valves and fasteners	AK8035	page 36
Service Kit - Whale Compac 50 Rocker Arm + Clamp Plate Kit	AS0352	page 36
Service Kit- Whale Compac 50 - Clamping Ring Kit	AS0353	page 36
Service Kit -Whale Compac 50 - Handle Assembly	AS0355	page 36
Service Kit-Whale Compac 50 - Deckplate Kit	AS0356	page 36

Mk 5 Manual Bilge Pumps

Service Kit - Whale Mk5 Universal - diaphragm, valves and fasteners	AK8050	page 34
Service Kit - Whale Mk5 Double acting - diaphragm, valves and fasteners	AK8060	page 34
Service Kit Whale - Mk5 Universal - Handle assembly 330mm	AS0511	page 34
Service kit - Whale Mk5 Universal- Rocker Arm Assembly	AS0521	page 34
Service kit - Whale Mk5 -Front Cover/Body Assembly	AS0522	page 34
Service kit -Whale Mk5 -U/Deck Rocker Arm Assembly	AS0531	page 34
Service Kit - Whale Mark V Double Acting - Rocker Arm Assembly	AS8551	page 34
Service Kit -Whale MarkV Double Acting - Clamping Plate + Nut Kit	AS8552	page 34
Service kit - Galter Kit For Deckplates (for underdeck models - Gusher 30 and 10, Titan, Urchin, MarkV)	AS3725	page 40

Gusher Urchin Manual Bilge Pumps

Service Kit - Whale Gusher Urchin -Neoprene diaphragm, valves, and fasteners	AK9003	page 30
Service Kit Whale Gusher Urchin Nitrile® diaphragm, valves and fasteners	AK9011	page 30
Service Kit - Whale Asy Handle Ss 240mm + Lanyard - for Urchin pumps	AS8680	page 30
Service Kit - Whale Gusher Urchin - Std Operating Lever Kit	AS9060	page 30
Service Kit - Whale Gusher Urchin - Fork Assembly Under deck + Rh	AS9061	page 30
Service Kit- Whale Gusher Urchin - Clamp Ring Kit Std+Rh	AS9062	page 30
Service Kit - Whale Gusher Urchin - Clamping Plate Kit	AS9066	page 30
Service Kit - Galter Kit For Deckplates (for underdeck models - Gusher 30 and 10, Titan, Urchin, MarkV)	AS3725	page 40
Thru-deck clamping ring kit	AS9064	page 30

Chimp Manual Bilge Pumps

Service Kit - Chimp mk 1 and 2 - Clamping Plate Kit	AS0128	
---	--------	--

Manual Bilge Pumps - General

Service kit - Galter Kit For Deckplates (for underdeck models - Gusher 30 and 10, Titan, Urchin, MarkV)	AS3725	page 40
---	--------	---------

Whale Support

Quick Guides

Freshwater – Spares

Manual Galley Pumps

Service Kit - Whale Flipper Mk3/4	AK0405	page 57
Service Kit - Whale Gusher Galley Mk2	AK0502	page 58
Service Kit - Whale Gusher Galley Mk3	AK0553	page 58
Service Kit - Whale V Pump Mk5/6	AK0618	page 58
Service Kit - Whale 1 litre Mk3/4	AK1304	page 60
Service Kit - Whale Gusher Galley Mk 3 - Piston/Spring Assembly	AS0556	page 58

Electric Galley Pumps

Service Kit - Whale Universal Freshwater- Replacement Head	AK1316	page 48
Service Kit - Whale Universal Freshwater Microswitch Kit	AK1317	page 48
Service Kit - Whale Universal Freshwater Strainer	AK1319	page 48

Faucets and Showers

Service Kit - Whale Elegance Tap & Shower	AK5030	page 62
Service Kit - Shower Handset For TB4180	AS4180	page 68
Service Kit - Shower Hose Chrome 2m (TB4180)	AS4191B	page 68
Service Kit - Whale Elegance Tap/ Shower Upgrade Kit Wit	AS5122	page 62
Service Kit - Whale Elegance Combo Handset Wit	AS5123	page 69
Service Kit - Whale Elegance Combo Handset Wit 1/2" Bsp	AS5133	page 69
Service Kit - Whale Elegance Shower Hose Assembly White	AS5145	page 69
Service Kit - Whale Elegance Shower Hose 1/2" Bsp White 1.7m	AS5146	page 69
Service Kit - Whale Elegance - Hose Assembly Swim'n'rinse 2.1m Wit	AS5147	page 74
Service Kit - Whale Elegance - Swim'n'rinse Hose 1/2" Bsp 2.1m	AS5148	page 74
Service Kit - Whale Elegance - Shower Hose Connector Wit	AS5149	page 69
Service Kit - Whale Elegance - Tap/Shower Upgrade Kit Beige	AS5626	page 62
Service Kit - Whale Elegance - Shower Hose Assembly Beige	AS5645	page 69

Spares – Grey Waste

Service Kit - Whale Grey Waste Tank Lid replacement	AK1001B	page 98
Service Kit - Whale Gulper® 220 - Clamping Ring Kit	AS1562	page 96
Service Kit - Whale Gulper® 320 replacement head kit	AK2050	page 94

Spares – Black / Toilet Waste

Gulper Electric Toilet Pump

Service Kit - Whale Gulper® Toilet Pump- Diaphragm, valves and fixings	AK1557	page 112
Service Kit - Whale Gulper® Toilet Pump- Clamping Ring Kit	AS1562	page 112

Manual Sanitation Pump

Service Kit - Whale Mark5 Sanitation - Diaphragm, valves and fixings	AK8050	page 114
Service Kit - Whale Mark5 Sanitation - Handle assembly 330mm	AS0511	page 114
Service Kit - Whale Mark 5 Sanitation - Rocker Arm Assembly	AS0521	page 114
Service Kit - Whale Mark 5 Sanitation - Front Cover/Body Assembly	AS0522	page 114
Service Kit - Whale Mark 5 Sanitation - Diaphragm Plate/Pivot Arm Kit	AS0561	page 114
Service Kit - Whale - Mk5 Sanitation I - Handle assembly 330mm	AS0511	page 114

Fishbox/ Baitwell – Spares

Service Kit - Gulper 320 head	AK2050	page 108
-------------------------------	--------	----------

Washdown - Spares

Service Kit - Washdown pump - Replacement Head	AK1316	page 80
Service Kit - Washdown pump - Microswitch Kit	AK1317	page 80
Service Kit - Washdown pump - Strainer - FOR SALTWATER USE	AK1329	page 80

Locker Doors – Spares

Service Kit - Henderson TCL3 + 2	AK4010	page 83
Service Kit - Cover & Locking Lever Kit TCL3	AS3006	page 83

Accessories at a Glance

Accessories - Electric Bilge

Electric Field Bilge Switch	BE9001	page 40
Mech Float Switch	BE9002	page 40
Electric Fixed Bilge Switch (with time delay)	BE9006	page 40
Valve Non-return Inline (3/4")	LV1219	page 40
Valve Non-return Inline (1 1/2") stepped connection	LV1215	page 40
Strumbox/ strainer 3/4" hose connections	SB3422	page 40
Skinfitting Plstc 3/4" hose connections	SF5018	page 40
Skinfitting Plstc 3/4" hose connections	SF5131	page 40
Skinfitting Plstc 1" hose connections	SF5204	page 40
Skinfitting Plstc 1 1/2" hose connections	SF5425	page 40

Accessories - Manual Bilge

Deck Plate Kit La With Lid	DP3804	page 40
Covered Deck Plate Kit Plstc	DP8504	page 40
Mtg Kit Whale Mk5 Conv. (wite)	DP9906	page 40
Mtg Kit Whale Mk5 Conv.	DP9906	page 40
Valve Diverter 1"	DV5630	page 40
Valve Diverter 1 1/2"	DV5606	page 40
Hose Fitting Elbow 1"	EB3364	page 40
Hose Fitting Elbow 1 1/2"	EB3488	page 40
Valve Non-return Inline	LV1215	page 40
Strainer S-e Valve	SB4222	page 40
Strainer T-e Valve	SB5866	page 40
Skinfitting Plstc 3/4"	SF5018	page 40
Skinfitting Plstc 3/4"	SF5131	page 40
Skinfitting Plstc 1"	SF5204	page 40
Skinfitting Plstc 1 1/2"	SF5425	page 40
Hose Fitting Y-piece 1 1/2"	YP6114	page 40

Accessories - Electric Galley

Inlet Strainer replacement	AK1309	page 76
Aquasource Clear Water Filter 15mm	WF1530	page 76
In line Pressure Switch	WU7207	page 76
Surge Damper (15mm connections)	WS7215	page 76
One Way check valves for 1/2" flexible hose (white)	FV1227	page 76

Accessories - Manual Galley

Hose Fitting Y-piece 1/2"	YP6130	page 76
One Way check valves for 1/2" flexible hose (white)	FV1227	page 76

Accessories - Taps and Showers

Rt Tap Microswitch Kit (for RT elegance range)	RT9000	page 76
--	--------	---------

Accessories - Deck Showers

Twist stowage bag - for neat stowage	AK0015	page 76
--------------------------------------	--------	---------

Accessories - Grey Waste

Gwt 8l 1 Switch 12/24volt	GW0810	page 98
Gwt 16l 1-switch	GW1610	page 98
Gwt 16l 1 Switch + Deutsch Sys	GW1631	page 98
Gwt 16l 2 - switch	GW1620	page 98
100l Grey Waste System 2 Pumps	GW1033	page 100
Skinfitting Plstc 3/4" hose connections	SF5018	page 102
Skinfitting Plstc 3/4" hose connections	SF5131	page 102
Skinfitting Plstc 1" hose connections	SF5204	page 102
Skinfitting Plstc 1 1/2" hose connections	SF5425	page 102
Hose Fitting Elbow 1"	EB3364	page 102
Hose Fitting Elbow 1 1/2"	EB3488	page 102
Valve Non-return Inline	LV1215	page 102
Skinfitting Plstc 3/4"	SF5018	page 102
Skinfitting Plstc 3/4"	SF5131	page 102
Skinfitting Plstc 1"	SF5204	page 102
Skinfitting Plstc 1 1/2"	SF5425	page 102
Hose Fitting Y-piece 1 1/2"	YP6114	page 102

Accessories - Black Waste

Valve Diverter 1 1/2"	DV5606	page 116
Skinfitting Plstc 1 1/2"	SF5425	page 116
Hose Fitting Y-piece 1 1/2"	YP6114	page 116
Hose Fitting Elbow 1 1/2"	EB3488	page 116

Accessories - Fishbox Evacuation

Hose Fitting Elbow 1"	EB3364	page 40
Hose Fitting Elbow 1 1/2"	EB3488	page 40
Valve Non-return Inline	LV1215	page 40
Strainer S-e Valve	SB4222	page 40
Strainer T-e Valve	SB5866	page 40
Skinfitting Plstc 3/4"	SF5018	page 40
Skinfitting Plstc 3/4"	SF5131	page 40
Skinfitting Plstc 1"	SF5204	page 40
Skinfitting Plstc 1 1/2"	SF5425	page 40
Hose Fitting Y-piece 1 1/2"	YP6114	page 40

Accessories - Washdown

inlet strainer for saltwater washdown pumps	AK1329	page 80
---	--------	---------

Accessories - General - Locker Doors

Whale Locker Door Tcl-2	LD2000	page 83
Whale Locker Door Tcl-3	LD3000	page 83
Whale Locker Door Tcl-4	LD4000	page 83
Whale Locker Door Tcl-4 Clear	LD4002	page 83

MUNSTER SIMMS ENGINEERING LIMITED AND WHALE WATER SYSTEMS INC
 (a subsidiary of Munster Simms Engineering Limited) ("Company")

STATEMENT OF LIMITED WARRANTY

The products manufactured and supplied by the Company ("Products"), are warranted to be free from material defects in design, workmanship and material under normal use ("Defects") for (unless otherwise extended in advance in writing by the Company) a period of 12 months from date of purchase, save that this warranty shall not apply where the Defect is attributable to defective materials supplied by third parties. In such event, the only remedy of the buyer of the Products ("Buyer") will be against that third party. This warranty applies only to Products that are properly installed and used in accordance with all oral and written maintenance and operation instructions provided by the Company. The Company shall not be liable for a breach of any of the warranties in this Statement of Limited Warranty if the Buyer makes any further use of the Products after giving the Company notice of any Defect or the Buyer alters or repairs such Products without the written consent of the Company. Products that have been disassembled or modified (without prior written approval of the Company), are not covered by this warranty.

All Products are covered by a 1 year limited warranty (detailed below) from (unless otherwise extended in advance in writing by the Company) date of purchase ("Standard Warranty"). In addition to the Standard Warranty, some individual Products are covered by a further warranty, as detailed in Table 1 below

("Additional Warranty").

In the event that any of the warranties offered by the Company are breached, the Company shall (at its discretion) repair, replace or issue a spares kit for the defective Product subject to prior examination at Company premises. If the Company complies with this paragraph, it shall have no further liability for a breach of the warranties in respect of such Products. Adjustment or replacement of defective parts made under this warranty will not extend the warranty period applicable either under the Standard Warranty and/or the Additional Warranty. The Company shall not bear any costs of removal, installation, transportation, or other charges that may arise in connection with a warranty claim by the Buyer. Such costs shall be the Buyer's sole responsibility. No claim in respect of defective Products will be valid unless the alleged defective Products are returned at the Buyer's expense to the Company for inspection, together with proof of purchase. Non-stock/ special order items are non-returnable by the Buyer in any circumstances, and this warranty does not apply to prototype models.

EXCLUSIONS:

The Company shall not be liable for any indirect loss or for any special, incidental, punitive or consequential damages suffered by the Buyer and/or any third party, whether this loss arises from breach of a duty in contract or tort or breach of a statutory duty or in any other way, including, without limitation, loss arising from the negligence, default, breach of duty, non-delivery, delay in delivery or defects or errors in the work undertaken by the Company pursuant to the terms of this Statement of Limited Warranty or in connection with any other claim arising in connection with manufacture and/or supply of the Products. In particular, the Company shall not be liable (without limitation) for:

- Loss of profits, increased production costs or other economic injury or loss;
- Loss of contracts or opportunity; and/or
- (insofar as is permitted by applicable law) damage to property of the Buyer or any third party.

The Company shall under no circumstances be liable for any breach of its obligations hereunder and/or under any contract governing sale and purchase of the Products ("Contract") resulting from causes beyond its control including but not limited to fires, strikes, lockouts, insurrection or riots, terrorism or civil disorder, embargoes, wrecks or delays in transportation, requirements or regulations of any governmental authority, tempest, earthquake or other natural disaster, flood, bursting or overflowing of water tanks, failure or shortage of power, fuel or other utilities, or loss of data and/or communications due to causes such as those referred to in this paragraph.

Copyright Whale 2011- All rights reserved. Whale is, A registered trademark of Munster Simms Engineering Limited (Bangor Northern Ireland) trading as Whale. Whale's policy is one of continuous improvement and we reserve the right to change specifications without prior notice. Illustrations are for guidance purposes only.

Please note that by contacting Whale Support you will be indicating your consent to receiving product updates, recall information, help guides and appropriate marketing messages from us via post, email or telephone unless you indicated an objection to receiving such messages.

Santoprene® is a registered trade name of Advanced Elastomer Systems, L.P. an Exxonmobi Chemical Affiliate. Delrin®, Teflon® and Neoprene are registered trade names of Dupont Neumours and Co. Monprene® is a registered trade name of Technore Apex

Powerboat photography courtesy of Fairline Boats PLC and Riviera Yachts.

Munster Simms Engineering Ltd, Old Belfast Road, Bangor, Co Down, N.Ireland BT19 1LT Tel: +44 (0)28 9127 0531 Fax: +44 (0)28 9146 6421
 Web: www.whalepumps.com Email info@whalepumps.com

This statement sets out the Company's entire liability in respect of the Products and the Company's liability under this statement shall be in lieu of all other warranties, conditions, terms and liabilities, express or implied, statutory or otherwise howsoever except any implied by law which cannot be excluded. All warranties, conditions and other terms implied by statute or common law (save for the conditions implied by section 12 of the Sale of Goods Act 1979) are, to the fullest extent permitted by law, excluded from the Contract.

Subject to the remaining provisions of this Statement of Limited Warranty, the Company's total liability in contract, tort (including negligence or breach of statutory duty), misrepresentation, restitution or otherwise, arising in connection with the performance or contemplated performance of the Contract and supply of the Products shall be limited to the Contract price.

Nothing in this Statement of Limited Warranty shall operate so as to exclude or restrict the Company's liability for death or personal injury caused by its negligence. The Company shall NOT be liable for any condition, warranty or representation made by a distributor or other person acting on behalf of the Company unless expressly confirmed by the Company in writing. This Statement of Limited Warranty shall be governed and construed in accordance with Northern Irish law and all disputes arising in connection hereto shall be submitted to the exclusive jurisdiction of the Northern Irish Courts.

Table 1:

Product type	2 years	3 years	5 years	10 years
Universal Series Pump	✓			
Chromed metal taps (TT)	✓			
Smartbail Bilge Pump		✓		
Orca Bilge Pump		✓		
Supersub Bilge Pump		✓		
Water Heater		✓		
Manual Bilge Pump			✓	
Manual Freshwater Pump			✓	
Manual Toilet Pump			✓	
Quick Connect Plumbing fittings				✓
WhaleX tubing				✓

The period of such Additional Warranty shall commence automatically the date the Standard Warranty expires.

Note that these periods may be further enhanced through special offers, or revisions. Please see your product documentation for details.

* Applies to BE: 0500, 0950, 1450 & 1454 only. All other Orca variants have a 1 year warranty. The period of such Additional Warranty shall commence automatically the date the Standard Warranty expires. Note that these periods may be further enhanced through special offers, or revisions. Please see your product documentation for details.

DISCLAIMER

All Products are rated and appropriate for use with water unless otherwise specified by the Company. Compatibility and suitability for other liquids should be verified in writing by the Company prior to such use. All specification information on Products included in Product literature is based on tests using clean cold water unless otherwise specified. Any performance / specification figures shown have been calculated using standard testing procedures. Where maximum output is stated, such maximum output refers to pumps acting at zero lift and zero head. Actual performance may vary depending on the application, installation and environmental factors. Neither the accuracy nor completeness of the information contained in any Product brochure is guaranteed by the Company and may be subject to change at its sole discretion. The Company may, at its sole discretion, change the technical performance, dimensions or appearance of any of its Products without prior notification to purchasers. The Company shall not be liable to a purchaser for any indirect or consequential loss or damage (whether for loss of profit, loss of business, depletion of goodwill or otherwise), costs, expenses or other claims for consequential compensation whatsoever (howsoever caused) which arise out of or in connection with the use of a Product. Where dimensions are stated, such dimensions are for guidance only. Inch measurements are conversions from millimetre dimensions and are shown to the nearest 1/16". US gallons volumes are conversions from litres and are also shown for guidance purposes only to the nearest 1/16. Please contact the Company directly if precise measurements are required.